

INSTRUCTION MANUAL

Circular Saw

5901B

5902B

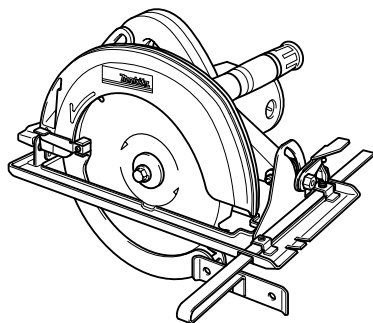

004126

 DOUBLE INSULATION

IMPORTANT: Read Before Using.

ENGLISH (Original instructions)

SPECIFICATIONS

Model		5901B	5902B
Blade diameter		235 mm	
Max. cutting depth	at 90°	85 mm	
	at 45°	60 mm	
	at 50°	53 mm	
No load speed (min ⁻¹)		4,100	
Overall length		380 mm	
Net weight		7.4 kg	6.8 kg
Safety class		▣ / II	▣ / II

- Due to our continuing programme of research and development, the specifications herein are subject to change without notice.
- Specifications may differ from country to country.
- Weight according to EPTA-Procedure 01/2003

END201-5

Symbols

The following show the symbols used for the equipment. Be sure that you understand their meaning before use.



- Read instruction manual.



- DOUBLE INSULATION



- Only for EU countries
Do not dispose of electric equipment together with household waste material! In observance of European Directive 2002/96/EC on waste electric and electronic equipment and its implementation in accordance with national law, electric equipment that have reached the end of their life must be collected separately and returned to an environmentally compatible recycling facility.

ENE028-1

Intended use

The tool is intended for performing lengthways and crossways straight cuts and mitre cuts with angles in wood while in firm contact with the workpiece.

ENF002-2

Power supply

The tool should be connected only to a power supply of the same voltage as indicated on the nameplate, and can only be operated on single-phase AC supply. They are double-insulated and can, therefore, also be used from sockets without earth wire.

GEA005-3

General Power Tool Safety

Warnings

 **WARNING** Read all safety warnings and all instructions. Failure to follow the warnings and

instructions may result in electric shock, fire and/or serious injury.

Save all warnings and instructions for future reference.

The term "power tool" in the warnings refers to your mains-operated (corded) power tool or battery-operated (cordless) power tool.

Work area safety

1. **Keep work area clean and well lit.** Cluttered or dark areas invite accidents.
2. **Do not operate power tools in explosive atmospheres, such as in the presence of flammable liquids, gases or dust.** Power tools create sparks which may ignite the dust or fumes.
3. **Keep children and bystanders away while operating a power tool.** Distractions can cause you to lose control.

Electrical safety

4. **Power tool plugs must match the outlet. Never modify the plug in any way. Do not use any adapter plugs with earthed (grounded) power tools.** Unmodified plugs and matching outlets will reduce risk of electric shock.
5. **Avoid body contact with earthed or grounded surfaces such as pipes, radiators, ranges and refrigerators.** There is an increased risk of electric shock if your body is earthed or grounded.
6. **Do not expose power tools to rain or wet conditions.** Water entering a power tool will increase the risk of electric shock.
7. **Do not abuse the cord. Never use the cord for carrying, pulling or unplugging the power tool. Keep cord away from heat, oil, sharp edges or moving parts.** Damaged or entangled cords increase the risk of electric shock.

8. **When operating a power tool outdoors, use an extension cord suitable for outdoor use.** Use of a cord suitable for outdoor use reduces the risk of electric shock.
9. **If operating a power tool in a damp location is unavoidable, use a residual current device (RCD) protected supply.** Use of an RCD reduces the risk of electric shock.
10. **Use of power supply via a RCD with a rated residual current of 30mA or less is always recommended.**

Personal safety

11. **Stay alert, watch what you are doing and use common sense when operating a power tool. Do not use a power tool while you are tired or under the influence of drugs, alcohol or medication.** A moment of inattention while operating power tools may result in serious personal injury.
12. **Use personal protective equipment. Always wear eye protection.** Protective equipment such as dust mask, non-skid safety shoes, hard hat, or hearing protection used for appropriate conditions will reduce personal injuries.
13. **Prevent unintentional starting. Ensure the switch is in the off-position before connecting to power source and/or battery pack, picking up or carrying the tool.** Carrying power tools with your finger on the switch or energising power tools that have the switch on invites accidents.
14. **Remove any adjusting key or wrench before turning the power tool on.** A wrench or a key left attached to a rotating part of the power tool may result in personal injury.
15. **Do not overreach. Keep proper footing and balance at all times.** This enables better control of the power tool in unexpected situations.
16. **Dress properly. Do not wear loose clothing or jewellery. Keep your hair, clothing, and gloves away from moving parts.** Loose clothes, jewellery or long hair can be caught in moving parts.
17. **If devices are provided for the connection of dust extraction and collection facilities, ensure these are connected and properly used.** Use of dust collection can reduce dust-related hazards.

Power tool use and care

18. **Do not force the power tool. Use the correct power tool for your application.** The correct power tool will do the job better and safer at the rate for which it was designed.
19. **Do not use the power tool if the switch does not turn it on and off.** Any power tool that cannot be controlled with the switch is dangerous and

must be repaired.

20. **Disconnect the plug from the power source and/or the battery pack from the power tool before making any adjustments, changing accessories, or storing power tools.** Such preventive safety measures reduce the risk of starting the power tool accidentally.
21. **Store idle power tools out of the reach of children and do not allow persons unfamiliar with the power tool or these instructions to operate the power tool.** Power tools are dangerous in the hands of untrained users.
22. **Maintain power tools. Check for misalignment or binding of moving parts, breakage of parts and any other condition that may affect the power tool's operation. If damaged, have the power tool repaired before use.** Many accidents are caused by poorly maintained power tools.
23. **Keep cutting tools sharp and clean.** Properly maintained cutting tools with sharp cutting edges are less likely to bind and are easier to control.
24. **Use the power tool, accessories and tool bits etc. in accordance with these instructions, taking into account the working conditions and the work to be performed.** Use of the power tool for operations different from those intended could result in a hazardous situation.

Service

25. **Have your power tool serviced by a qualified repair person using only identical replacement parts.** This will ensure that the safety of the power tool is maintained.
26. **Follow instruction for lubricating and changing accessories.**
27. **Keep handles dry, clean and free from oil and grease.**

GEB013-3

CIRCULAR SAW SAFETY WARNINGS

Danger:

1. **Keep hands away from cutting area and the blade. Keep your second hand on auxiliary handle, or motor housing.** If both hands are holding the saw, they cannot be cut by the blade.
2. **Do not reach underneath the workpiece.** The guard cannot protect you from the blade below the workpiece.
3. **Adjust the cutting depth to the thickness of the workpiece.** Less than a full tooth of the blade teeth should be visible below the workpiece.
4. **Never hold piece being cut in your hands or across your leg. Secure the workpiece to stable platform.** It is important to support the work properly to minimize body exposure, blade binding,

or loss of control.

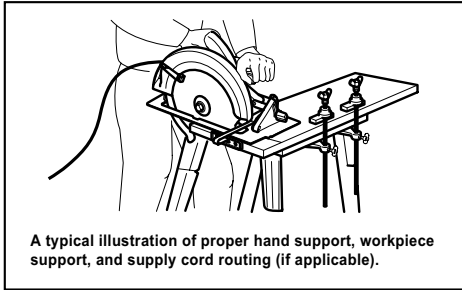

000157

5. **Hold power tool by insulated gripping surfaces when performing an operation where the cutting tool may contact hidden wiring or its own cord.** Contact with a "live" wire will also make exposed metal parts of the power tool "live" and shock the operator.
6. **When ripping always use a rip fence or straight edge guide.** This improves the accuracy cut and reduces the chance of blade binding.
7. **Always use blades with correct size and shape (diamond versus round) of arbour holes.** Blades that do not match the mounting hardware of the saw will run eccentrically, causing loss of control.
8. **Never use damaged or incorrect blade washers or bolt.** The blade washers and bolt were specially designed for your saw, for optimum performance and safety of operation.
9. **Causes and Operator Prevention of Kickback:**
 - kickback is a sudden reaction to a pinched, bound or misaligned saw blade, causing an uncontrolled saw to lift up and out of the workpiece toward the operator;
 - when the blade is pinched or bound tightly by the kerf closing down, the blade stalls and the motor reaction drives the unit rapidly back toward the operator;
 - if the blade becomes twisted or misaligned in the cut, the teeth at the back edge of the blade can dig into the top surface of the wood causing the blade to climb out of the kerf and jump back toward the operator.

Kickback is the result of saw misuse and/or incorrect operating procedures or conditions and can be avoided by taking proper precautions as given below.

- **Maintain a firm grip with both hands on the saw and position your arms to resist kickback forces. Position your body to either side of the blade, but not in line with**

the blade. Kickback could cause the saw to jump backwards, but kickback forces can be controlled by the operator, if proper precautions are taken.

- **When blade is binding, or when interrupting a cut for any reason, release the trigger and hold the saw motionless in the material until the blade comes to a complete stop. Never attempt to remove the saw from the work or pull the saw backward while the blade is in motion or kickback may occur.** Investigate and take corrective actions to eliminate the cause of blade binding.
- **When restarting a saw in the workpiece, centre the saw blade in the kerf and check that saw teeth are not engaged into the material.** If saw blade is binding, it may walk up or kickback from the workpiece as the saw is restarted.
- **Support large panels to minimise the risk of blade pinching and kickback.** Large panels tend to sag under their own weight. Supports must be placed under the panel on both sides, near the line of cut and near the edge of the panel.

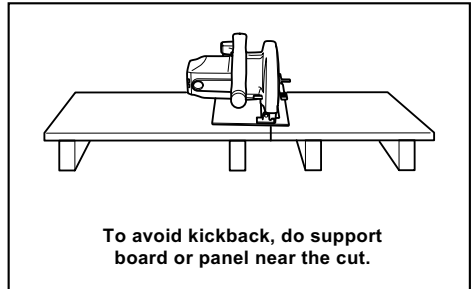

000154

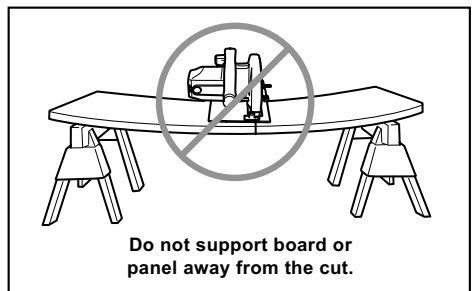

000156

- **Do not use dull or damaged blades.** Unsharpened or improperly set blades

produce narrow kerf causing excessive friction, blade binding and kickback.

- **Blade depth and bevel adjusting locking levers must be tight and secure before making cut.** If blade adjustment shifts while cutting, it may cause binding and kickback.
 - **Use extra caution when making a "plunge cut" into existing walls or other blind areas.** The protruding blade may cut objects that can cause kickback.
10. **Check lower guard for proper closing before each use. Do not operate the saw if lower guard does not move freely and close instantly. Never clamp or tie the lower guard into the open position.** If saw is accidentally dropped, lower guard may be bent. Raise the lower guard with the retracting handle and make sure it moves freely and does not touch the blade or any other part, in all angles and depths of cut.
 11. **Check the operation of the lower guard spring. If the guard and the spring are not operating properly, they must be serviced before use.** Lower guard may operate sluggishly due to damaged parts, gummy deposits, or a build-up of debris.
 12. **Lower guard should be retracted manually only for special cuts such as "plunge cuts" and "compound cuts."** Raise lower guard by retracting handle and as soon as blade enters the material, the lower guard must be released. For all other sawing, the lower guard should operate automatically.
 13. **Always observe that the lower guard is covering the blade before placing saw down on bench or floor.** An unprotected, coasting blade will cause the saw to walk backwards, cutting whatever is in its path. Be aware of the time it takes for the blade to stop after switch is released.
 14. **ALWAYS hold the tool firmly with both hands. NEVER place your hand or fingers behind the saw.** If kickback occurs, the saw could easily jump backwards over your hand, leading to serious personal injury.

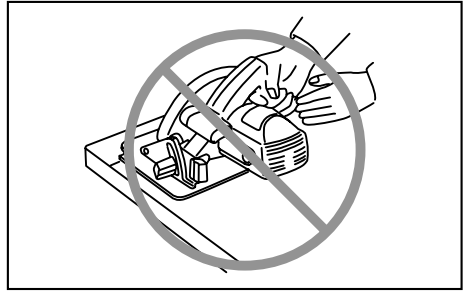

000194

15. **Never force the saw. Push the saw forward at a speed so that the blade cuts without slowing.** Forcing the saw can cause uneven cuts, loss of accuracy, and possible kickback.
16. **Use extra caution when cutting damp wood, pressure treated lumber, or wood containing knots.** Adjust speed of cut to maintain smooth advancement of tool without decrease in blade speed.
17. **Do not attempt to remove cut material when blade is moving. Wait until blade stops before grasping cut material.** CAUTION: Blades coast after turn off.
18. **Avoid Cutting Nails.** Inspect for and remove all nails from lumber before cutting.
19. **Place the wider portion of the saw base on that part of the workpiece which is solidly supported, not on the section that will fall off when the cut is made.** As examples, Fig. 1 illustrates the RIGHT way to cut off the end of a board, and Fig. 2 the WRONG way. If the workpiece is short or small, clamp it down. **DO NOT TRY TO HOLD SHORT PIECES BY HAND!**

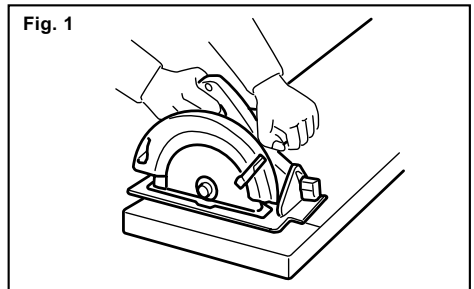

000147

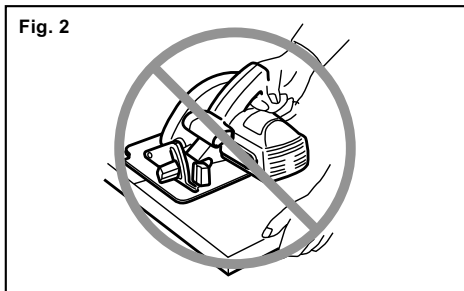

000150

20. Before setting the tool down after completing a cut, be sure that the lower guard has closed and the blade has come to a complete stop.
21. Never attempt to saw with the circular saw held upside down in a vise. This is extremely dangerous and can lead to serious accidents.

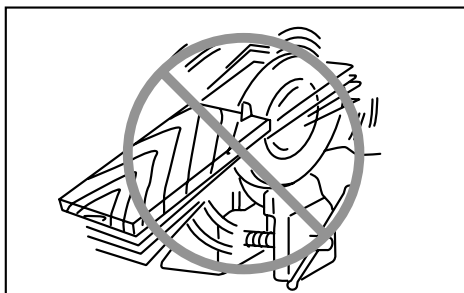

000029

22. Some material contains chemicals which may be toxic. Take caution to prevent dust inhalation and skin contact. Follow material supplier safety data.
23. Do not stop the blades by lateral pressure on the saw blade.
24. Always use blades recommended in this manual. Do not use any abrasive wheels.
25. Keep blade sharp and clean. Gum and wood pitch hardened on blades slows saw and increases potential for kickback. Keep blade clean by first removing it from tool, then cleaning it with gum and pitch remover, hot water or kerosene. Never use gasoline.
26. Wear a dust mask and hearing protection when use the tool.

SAVE THESE INSTRUCTIONS.

⚠WARNING:

DO NOT let comfort or familiarity with product (gained from repeated use) replace strict adherence to safety rules for the subject product. **MISUSE** or failure to follow the safety rules stated in this instruction manual may cause serious personal injury.

FUNCTIONAL DESCRIPTION

⚠CAUTION:

- Always be sure that the tool is switched off and unplugged before adjusting or checking function on the tool.

Adjusting depth of cut

⚠CAUTION:

- After adjusting the depth of cut, always tighten the lever securely.

Loosen the lever on the side of handle and move the base up or down.

At the desired depth of cut, secure the base by tightening the lever.

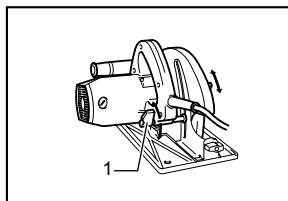

1. Lever

004127

For cleaner, safer cuts, set cut depth so that no more than one blade tooth projects below workpiece. Using proper cut depth helps to reduce potential for dangerous KICKBACKS which can cause personal injury.

Bevel cutting

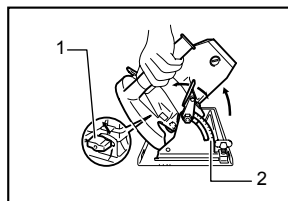

1. Thumb nut
2. Bevel scale plate

004128

Loosen the lever in front and the thumb nut in back, and tilt the tool to the desired angle for bevel cuts (0° - 50°). Secure the lever and the thumb nut clockwise tightly after making adjustment.

Sighting

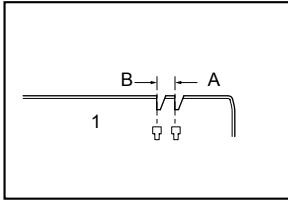

1. Base plate

004129

For straight cuts, align the A position on the front of the base with your cutting line. For 45° bevel cuts, align the B position with it.

Switch action

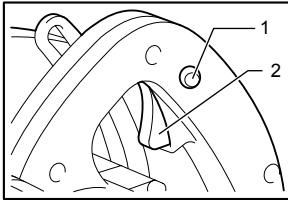

1. Lock button /
Lock-off button
2. Switch trigger

008080

⚠CAUTION:

- Before plugging in the tool, always check to see that the switch trigger actuates properly and returns to the "OFF" position when released.

For tool with lock button

To start the tool, simply pull the switch trigger. Release the switch trigger to stop.

For continuous operation, pull the switch trigger and then push in the lock button.

To stop the tool from the locked position, pull the switch trigger fully, then release it.

For tool with lock-off button

To prevent the switch trigger from being accidentally pulled, a lock-off button is provided. To start the tool, push in the lock-off button and pull the switch trigger. Release the switch trigger to stop.

For tool without lock button and lock-off button

To start the tool, simply pull the switch trigger. Release the switch trigger to stop.

ASSEMBLY

⚠CAUTION:

- Always be sure that the tool is switched off and unplugged before carrying out any work on the tool.

Removing or installing saw blade

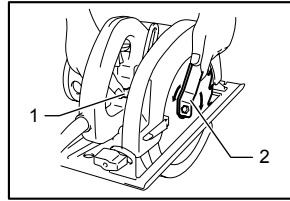

1. Shaft lock
2. Wrench

004131

⚠CAUTION:

- Be sure the blade is installed with teeth pointing up at the front of the tool.
- Use only the Makita wrench to install or remove the blade.

To remove the blade, press the shaft lock so that the blade cannot revolve and use the wrench to loosen the hex bolt counterclockwise. Then remove the hex bolt, outer flange and blade.

To install the blade, follow the removal procedure in reverse. **BE SURE TO TIGHTEN THE HEX BOLT CLOCKWISE SECURELY.**

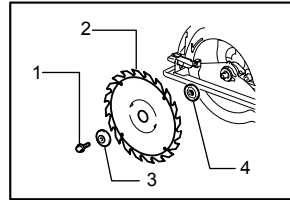

1. Hex bolt
2. Saw blade
3. Outer flange
4. Inner flange

004132

The following blades can be used with the tool.

Max. dia.	Min. dia.
235 mm	230 mm

006399

Side grip (auxiliary handle)

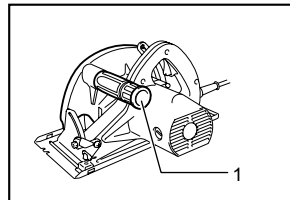

1. Side grip

004133

Install the side grip on the tool securely before operation.

Joint set (optional accessory)

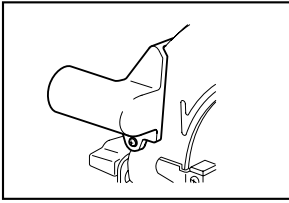

004134

Attach the joint to the chip chute in the blade case and secure it with the screws. Remove the lever attached to the main unit and attach lever of joint set.

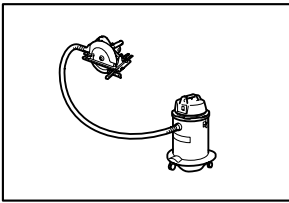

004135

OPERATION

⚠CAUTION:

- Be sure to move the tool forward in a straight line gently. Forcing or twisting the tool will result in overheating the motor and dangerous kickback, possibly causing severe injury.

Hold the tool firmly. The tool is provided with both a front grip and rear handle. Use both to best grasp the tool. If both hands are holding saw, they cannot be cut by the blade. Set the base on the workpiece to be cut without the blade making any contact. Then turn the tool on and wait until the blade attains full speed. Now simply move the tool forward over the workpiece surface, keeping it flat and advancing smoothly until the sawing is completed.

To get clean cuts, keep your sawing line straight and your speed of advance uniform. If the cut fails to properly follow your intended cut line, do not attempt to turn or force the tool back to the cut line. Doing so may bind the blade and lead to dangerous kickback and possible serious injury. Release switch, wait for blade to stop and then withdraw tool. Realign tool on new cut line, and start cut again. Attempt to avoid positioning which exposes operator to chips and wood dust being ejected from saw. Use eye protection to help avoid injury.

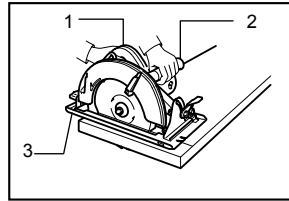

004136

1. Rear handle
2. Front grip
3. Base

Rip fence (Guide rule)

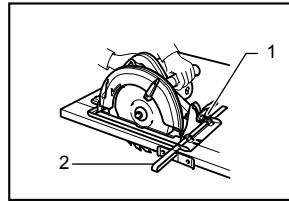

004137

1. Screw
2. Rip fence (Guide rule)

The handy rip fence allows you to do extra-accurate straight cuts. Simply slide the rip fence up snugly against the side of the workpiece and secure it in position with the screw on the front of the base. It also makes repeated cuts of uniform width possible.

MAINTENANCE

⚠CAUTION:

- Always be sure that the tool is switched off and unplugged before attempting to perform inspection or maintenance.
- Never use gasoline, benzine, thinner, alcohol or the like. Discoloration, deformation or cracks may result.

Replacing carbon brushes

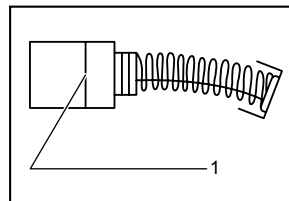

001145

1. Limit mark

Remove and check the carbon brushes regularly. Replace when they wear down to the limit mark. Keep the carbon brushes clean and free to slip in the holders. Both carbon brushes should be replaced at the same time. Use only identical carbon brushes.

Use a screwdriver to remove the brush holder caps. Take out the worn carbon brushes, insert the new ones and

secure the brush holder caps.

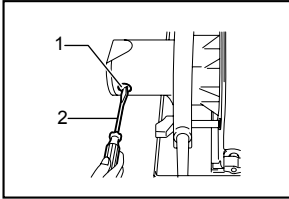

1. Brush holder cap
2. Screwdriver

004138

To maintain product SAFETY and RELIABILITY, repairs, any other maintenance or adjustment should be performed by Makita Authorized Service Centers, always using Makita replacement parts.

ACCESSORIES

⚠CAUTION:

- These accessories or attachments are recommended for use with your Makita tool specified in this manual. The use of any other accessories or attachments might present a risk of injury to persons. Only use accessory or attachment for its stated purpose.

If you need any assistance for more details regarding these accessories, ask your local Makita Service Center.

- Saw blades
- Rip fence (Guide rule)
- Offset wrench 13
- Joint set

Makita Corporation
Anjo, Aichi, Japan

884289C6

www.makita.com