

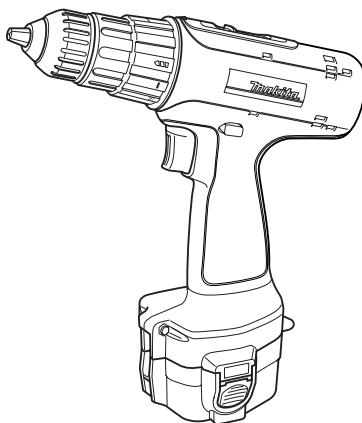

Cordless Driver Drill

MODEL 6327D

MODEL 6328D



004544

I N S T R U C T I O N M A N U A L

⚠ WARNING:

For your personal safety, READ and UNDERSTAND before using.
SAVE THESE INSTRUCTIONS FOR FUTURE REFERENCE.

SPECIFICATIONS

Model		6327D	6328D
Capacities	Steel	13 mm	13 mm
	Wood	24 mm	
	Wood screw	5.1 mm x 63 mm	
No load speed (min ⁻¹)	High	0 - 1,100	
	Low	0 - 350	
Overall length		220 mm	
Net weight		1.6 kg	1.7 kg
Rated voltage		D.C. 12 V	D.C. 14.4 V

- Due to our continuing programme of research and development, the specifications herein are subject to change without notice.
- Note: Specifications may differ from country to country.

Intended use

The tool is intended for drilling and screw driving in wood, metal and plastic.

For European countries only

Noise and Vibration

The typical A-weighted sound pressure level is not more than 70 dB (A).

The noise level under working may exceed 85 dB (A).

– Wear ear protection. –

The typical weighted root mean square acceleration value is not more than 2.5 m/s².

EC-DECLARATION OF CONFORMITY

We declare under our sole responsibility that this product is in compliance with the following standards of standardized documents, EN50260, EN55014 in accordance with Council Directives, 89/336/EEC, 98/37/EC.

Yasuhiko Kanzaki **CE 2003**



Director

MAKITA INTERNATIONAL EUROPE LTD.

Michigan Drive, Tongwell, Milton Keynes, Bucks MK15 8JD, ENGLAND

SAFETY INSTRUCTIONS

ENA002-2

WARNING:

When using battery operated tools basic safety precautions, including the following, should be followed to reduce the risk of fire, leaking batteries and personal injury: Read these instructions before operating this product and save these instructions.

For safe operations:

- 1. Keep work area clean.**
Cluttered areas and benches invite injuries.
- 2. Consider the work environment.**
Do not expose the tool to rain. Keep work area well lit. Do not use tools in the presence of flammable liquids or gases.
- 3. Keep children away.**
Do not let visitors touch the tool. Keep visitors away from work area.
- 4. Store batteries or idle tools.**
When not in use, tools and batteries should be stored separately in a dry, high or locked up place, out of reach of children.
Ensure that battery terminals cannot be shorted by other metal parts such as screws, nails, etc.
- 5. Do not force the tool.**
It will do the job better and safer at the rate for which it was intended.
- 6. Use the right tool.**
Do not force small tools or attachments to do the job of a heavy duty tool. Do not use tools for purposes not intended.
- 7. Dress properly.**
Do not wear loose clothing or jewellery, they can be

-
- caught in moving parts. Non-skid footwear is recommended when working outdoors. Wear protecting hair covering to contain long hair.
8. **Use protective equipment.**
Use safety glasses and if the cutting operation is dusty, a face or dust mask.
 9. **Connect dust extraction equipment.**
If devices are provided for the connection of dust extraction and collection ensure these are connected and properly used.
 10. **Do not abuse the supply cord (if fitted).**
Never carry the tool by the cord or yank it to disconnect from the socket. Keep the cord away from heat, oil and sharp edges.
 11. **Secure the work.**
Use clamps or a vice to hold the work. It is safer than using your hand and it frees both hands to operate the tool.
 12. **Do not over-reach.**
Keep proper footing and balance at all times.
 13. **Maintain tools with care.**
Keep cutting tools sharp and clean for better and safer performance. Follow instructions for lubrication and changing accessories. Inspect tool cords periodically and if damaged have repaired by an authorized service facility.
 14. **Disconnect tools.**
Where the design permits, disconnect the tool from its battery pack when not in use, before servicing and when changing accessories such as blades, bits and cutters.
 15. **Remove adjusting keys and wrenches.**
Form the habit of checking to see that keys and adjusting wrenches are removed from the tool before turning it on.
 16. **Avoid unintentional starting.**
Do not carry the tool with a finger on the switch.
 17. **Stay alert.**
Watch what you are doing. Use common sense. Do not operate the tool when you are tired.
 18. **Check damaged parts.**
Before further use of the tool, a guard or other part that is damaged should be carefully checked to determine that it will operate properly and perform its intended function. Check for alignment of moving parts, free running of moving parts, breakage of parts, mounting and any other condition that may affect its operation. A guard or other part that is damaged should be properly repaired or replaced by an authorized service facility unless otherwise indicated in this instruction manual. Have defective switches replaced by an authorized service facility. Do not use the tool if the switch does not turn it on and off.
 19. **Warning.**
The use of any accessory or attachment, other than recommended in this instruction manual or the catalog, may present a risk of personal injury. Ensure that the battery pack is correct for the tool. Ensure that the outside surface of battery pack or tool is clean and dry before plugging into charger. Ensure that batteries are charged using the correct charger recommended by the manufacturer. Incorrect use may result in a risk of electric shock, overheating or leakage of corrosive liquid from the battery.
 20. **Have your tool repaired by a qualified person.**
This tool is constructed in accordance with the relevant safety requirements. Repairs should only be carried out by qualified persons using original spare parts, otherwise this may result in considerable danger to the user.
 21. **Disposal of battery.**
Ensure battery is disposed of safely as instructed by the manufacturer.

ADDITIONAL SAFETY RULES FOR TOOL

ENB022-1

1. **Be aware that this tool is always in an operating condition, because it does not have to be plugged into an electrical outlet.**
2. **Hold tool by insulated gripping surfaces when performing an operation where the cutting tool may contact hidden wiring.** Contact with a "live" wire will also make exposed metal parts of the tool "live" and shock the operator.
3. **Always be sure you have a firm footing.**
4. **Be sure no one is below when using the tool in high locations.**
5. **Hold the tool firmly.**
6. **Keep hands away from rotating parts.**
7. **Do not leave the tool running. Operate the tool only when hand-held.**
8. **Do not touch the drill bit or the workpiece immediately after operation; they may be extremely hot and could burn your skin.**

SAVE THESE INSTRUCTIONS

IMPORTANT SAFETY INSTRUCTIONS FOR BATTERY CARTRIDGE

ENC004-1

1. Before using battery cartridge, read all instructions and cautionary markings on (1) battery charger, (2) battery, and (3) product using battery.
 2. Do not disassemble battery cartridge.
 3. If operating time has become excessively shorter, stop operating immediately. It may result in a risk of overheating, possible burns and even an explosion.
 4. If electrolyte gets into your eyes, rinse them out with clear water and seek medical attention right away. It may result in loss of your eyesight.
 5. Always cover the battery terminals with the battery cover when the battery cartridge is not used.
 6. Do not short the battery cartridge:
 - (1) Do not touch the terminals with any conductive material.
 - (2) Avoid storing battery cartridge in a container with other metal objects such as nails, coins, etc.
 - (3) Do not expose battery cartridge to water or rain.
- A battery short can cause a large current flow, overheating, possible burns and even a breakdown.
7. Do not store the tool and battery cartridge in locations where the temperature may reach or exceed 50°C (122°F).
 8. Do not incinerate the battery cartridge even if it is severely damaged or is completely worn out. The battery cartridge can explode in a fire.
 9. Be careful not to drop or strike battery.

SAVE THESE INSTRUCTIONS

Tips for maintaining maximum battery life

1. Charge the battery cartridge before completely discharged.
Always stop tool operation and charge the battery cartridge when you notice less tool power.
2. Never recharge a fully charged battery cartridge. Overcharging shortens the battery service life.
3. Charge the battery cartridge with room temperature at 10°C - 40°C (50°F - 104°F). Let a hot battery cartridge cool down before charging it.
4. Charge the Nickel Metal Hydride battery cartridge when you do not use it for more than six months.

FUNCTIONAL DESCRIPTION

CAUTION:

- Always be sure that the tool is switched off and the battery cartridge is removed before adjusting or checking function on the tool.

Installing or removing battery cartridge

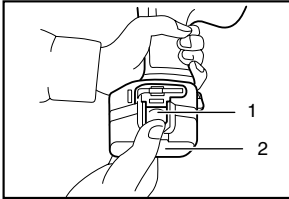

1. Button
2. Battery cartridge

- Always switch off the tool before insertion or removal of the battery cartridge.
- To remove the battery cartridge, withdraw it from the tool while pressing the buttons on both sides of the cartridge.
- To insert the battery cartridge, align the tongue on the battery cartridge with the groove in the housing and slip it into place. Always insert it all the way until it locks in place with a little click. If not, it may accidentally fall out of the tool, causing injury to you or someone around you.
- Do not use force when inserting the battery cartridge. If the cartridge does not slide in easily, it is not being inserted correctly.

Switch action

CAUTION:

- Before inserting the battery cartridge into the tool, always check to see that the switch trigger actuates properly and returns to the "OFF" position when released.

To start the tool, simply pull the switch trigger. Tool speed is increased by increasing pressure on the switch trigger. Release the switch trigger to stop.

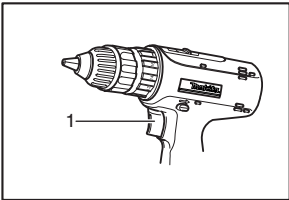

1. Switch trigger

Reversing switch action

This tool has a reversing switch to change the direction of rotation. Depress the reversing switch lever from the A side for clockwise rotation or from the B side for counterclockwise rotation.

When the reversing switch lever is in the neutral position, the switch trigger cannot be pulled.

CAUTION:

- Always check the direction of rotation before operation.
- Use the reversing switch only after the tool comes to a complete stop. Changing the direction of rotation before the tool stops may damage the tool.
- When not operating the tool, always set the reversing switch lever to the neutral position.

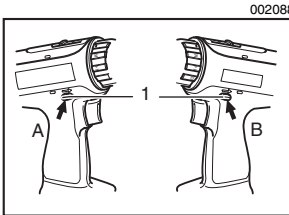

1. Reversing switch lever

002096

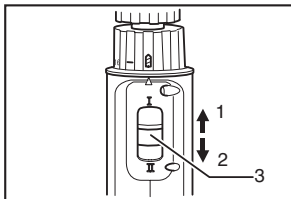

1. Low speed
2. High speed
3. Speed change lever

Speed change

To change the speed, first switch off the tool and then slide the speed change lever to the "II" side for high speed or "I" side for low speed. Be sure that the speed change lever is set to the correct position before operation. Use the right speed for your job.

⚠ CAUTION:

- Always set the speed change lever fully to the correct position. If you operate the tool with the speed change lever positioned halfway between the "I" side and "II" side, the tool may be damaged.
- Do not use the speed change lever while the tool is running. The tool may be damaged.

002104

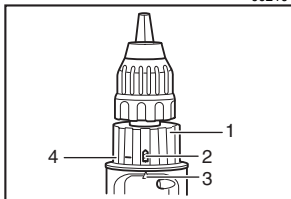

1. Adjusting ring
2. Drill marking
3. Pointer
4. Graduations

Adjusting the fastening torque

The fastening torque can be adjusted in 17 steps by turning the adjusting ring so that its graduations are aligned with the pointer on the tool body. The fastening torque is minimum when the number 1 is aligned with the pointer, and maximum when the 17 marking is aligned with the pointer.

The clutch will slip at various torque levels when set at the number 1 to 16. The clutch is designed not to slip at the 17 marking.

Before actual operation, drive a trial screw into your material or a piece of duplicate material to determine which torque level is required for a particular application.

NOTE:

- The adjusting ring does not lock when the pointer is positioned only halfway between the graduations.
- Do not operate the tool with the adjusting ring set between the number 16 and the 17 marking. The tool may be damaged.

ASSEMBLY

002118

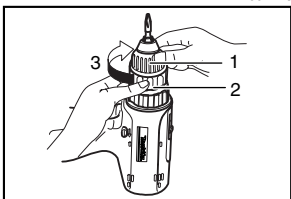

1. Sleeve
2. Ring
3. Tighten

⚠ CAUTION:

- Always be sure that the tool is switched off and the battery cartridge is removed before carrying out any work on the tool.

Installing or removing driver bit or drill bit

Hold the ring and turn the sleeve counterclockwise to open the chuck jaws. Place the bit in the chuck as far as it will go. Hold the ring firmly and turn the sleeve clockwise to tighten the chuck.

To remove the bit, hold the ring and turn the sleeve counterclockwise.

OPERATION

002134

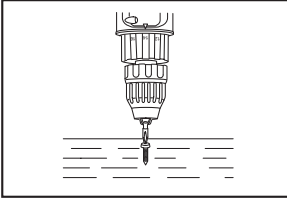

Screwdriving operation

⚠ CAUTION:

- Adjust the adjusting ring to the proper torque level for your work.

Place the point of the driver bit in the screw head and apply pressure to the tool. Start the tool slowly and then increase the speed gradually. Release the switch trigger as soon as the clutch cuts in.

⚠ CAUTION:

- Make sure that the driver bit is inserted straight in the screw head, or the screw and/or bit may be damaged.

NOTE:

- When driving wood screws, predrill pilot holes to make driving easier and to prevent splitting of the workpiece. See the chart.

C00080

Nominal diameter of wood screw (mm)	Recommended size of pilot hole (mm)
3.1	2.0 - 2.2
3.5	2.2 - 2.5
3.8	2.5 - 2.8
4.5	2.9 - 3.2
4.8	3.1 - 3.4
5.1	3.3 - 3.6
5.5	3.7 - 3.9
5.8	4.0 - 4.2
6.1	4.2 - 4.4

Drilling operation

First, turn the adjusting ring so that the pointer points to the  marking. Then proceed as follows.

Drilling in wood

When drilling in wood, the best results are obtained with wood drills equipped with a guide screw. The guide screw makes drilling easier by pulling the bit into the workpiece.

Drilling in metal

To prevent the bit from slipping when starting a hole, make an indentation with a center-punch and hammer at the point to be drilled. Place the point of the bit in the indentation and start drilling.

Use a cutting lubricant when drilling metals. The exceptions are iron and brass which should be drilled dry.

⚠ CAUTION:

- Pressing excessively on the tool will not speed up the drilling. In fact, this excessive pressure will only serve to damage the tip of your bit, decrease the tool performance and shorten the service life of the tool.
- There is a tremendous force exerted on the tool/bit at the time of hole break through. Hold the tool firmly and exert care when the bit begins to break through the workpiece.

-
- A stuck bit can be removed simply by setting the reversing switch to reverse rotation in order to back out. However, the tool may back out abruptly if you do not hold it firmly.
 - Always secure small workpieces in a vise or similar hold-down device.
 - If the tool is operated continuously until the battery cartridge has discharged, allow the tool to rest for 15 minutes before proceeding with a fresh battery.

MAINTENANCE

CAUTION:

- Always be sure that the tool is switched off and the battery cartridge is removed before attempting to perform inspection or maintenance.

To maintain product SAFETY and RELIABILITY, repairs, any other maintenance or adjustment should be performed by Makita Authorized Service Centers, always using Makita replacement parts.

ACCESSORIES

CAUTION:

- These accessories or attachments are recommended for use with your Makita tool specified in this manual. The use of any other accessories or attachments might present a risk of injury to persons. Only use accessory or attachment for its stated purpose.

If you need any assistance for more details regarding these accessories, ask your local Makita service center.

- Drill bits
- Screw bits
- Various type of Makita genuine batteries and chargers
- Rubber pad assembly
- Wool bonnet
- Foam polishing pad

Memo

Memo

Memo

Makita Corporation