

INSTRUCTION MANUAL

# Screwdriver

6801B

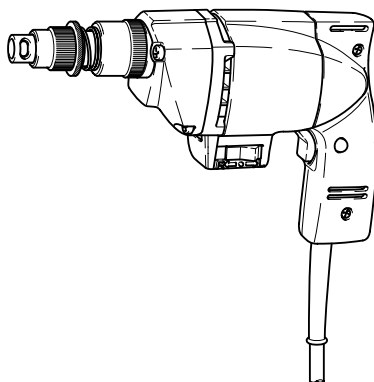

 DOUBLE INSULATION

013632

**IMPORTANT:** Read Before Using.

## ENGLISH (Original instructions)

# SPECIFICATIONS

Model		6801B
Capacities	Self drilling screw	6 mm
No load speed (min <sup>-1</sup> )		2.000
Overall length		270 mm
Net weight		2.1 kg
Safety class		□/II

- Due to our continuing program of research and development, the specifications herein are subject to change without notice.
- Specifications may differ from country to country.

END201-6

## Symbols

The following show the symbols used for the equipment. Be sure that you understand their meaning before use.



- Read instruction manual.



- DOUBLE INSULATION



- Only for EU countries  
Do not dispose of electric equipment together with household waste material!

In observance of European Directive 2012/19/EU on waste electric and electronic equipment and its implementation in accordance with national law, electric equipment that have reached the end of their life must be collected separately and returned to an environmentally compatible recycling facility.

ENE033-1

## Intended use

The tool is intended for screw driving in wood, metal and plastic.

ENF002-2

## Power supply

The tool should be connected only to a power supply of the same voltage as indicated on the nameplate, and can only be operated on single-phase AC supply. They are double-insulated and can, therefore, also be used from sockets without earth wire.

GEA005-3

## General Power Tool Safety

### Warnings

**⚠ WARNING Read all safety warnings and all instructions.** Failure to follow the warnings and instructions may result in electric shock, fire and/or serious injury.

## Save all warnings and instructions for future reference.

The term "power tool" in the warnings refers to your mains-operated (corded) power tool or battery-operated (cordless) power tool.

### Work area safety

1. **Keep work area clean and well lit.** Cluttered or dark areas invite accidents.
2. **Do not operate power tools in explosive atmospheres, such as in the presence of flammable liquids, gases or dust.** Power tools create sparks which may ignite the dust or fumes.
3. **Keep children and bystanders away while operating a power tool.** Distractions can cause you to lose control.

### Electrical safety

4. **Power tool plugs must match the outlet. Never modify the plug in any way. Do not use any adapter plugs with earthed (grounded) power tools.** Unmodified plugs and matching outlets will reduce risk of electric shock.
5. **Avoid body contact with earthed or grounded surfaces such as pipes, radiators, ranges and refrigerators.** There is an increased risk of electric shock if your body is earthed or grounded.
6. **Do not expose power tools to rain or wet conditions.** Water entering a power tool will increase the risk of electric shock.
7. **Do not abuse the cord. Never use the cord for carrying, pulling or unplugging the power tool. Keep cord away from heat, oil, sharp edges or moving parts.** Damaged or entangled cords increase the risk of electric shock.
8. **When operating a power tool outdoors, use an extension cord suitable for outdoor use.** Use of a cord suitable for outdoor use reduces the risk of electric shock.
9. **If operating a power tool in a damp location is unavoidable, use a residual current device (RCD) protected supply.** Use of an RCD

reduces the risk of electric shock.

10. **Use of power supply via a RCD with a rated residual current of 30mA or less is always recommended.**

#### Personal safety

11. **Stay alert, watch what you are doing and use common sense when operating a power tool. Do not use a power tool while you are tired or under the influence of drugs, alcohol or medication.** A moment of inattention while operating power tools may result in serious personal injury.
12. **Use personal protective equipment. Always wear eye protection.** Protective equipment such as dust mask, non-skid safety shoes, hard hat, or hearing protection used for appropriate conditions will reduce personal injuries.
13. **Prevent unintentional starting. Ensure the switch is in the off-position before connecting to power source and/or battery pack, picking up or carrying the tool.** Carrying power tools with your finger on the switch or energising power tools that have the switch on invites accidents.
14. **Remove any adjusting key or wrench before turning the power tool on.** A wrench or a key left attached to a rotating part of the power tool may result in personal injury.
15. **Do not overreach. Keep proper footing and balance at all times.** This enables better control of the power tool in unexpected situations.
16. **Dress properly. Do not wear loose clothing or jewellery. Keep your hair, clothing, and gloves away from moving parts.** Loose clothes, jewellery or long hair can be caught in moving parts.
17. **If devices are provided for the connection of dust extraction and collection facilities, ensure these are connected and properly used.** Use of dust collection can reduce dust-related hazards.

#### Power tool use and care

18. **Do not force the power tool. Use the correct power tool for your application.** The correct power tool will do the job better and safer at the rate for which it was designed.
19. **Do not use the power tool if the switch does not turn it on and off.** Any power tool that cannot be controlled with the switch is dangerous and must be repaired.
20. **Disconnect the plug from the power source and/or the battery pack from the power tool before making any adjustments, changing accessories, or storing power tools.** Such preventive safety measures reduce the risk of starting the power tool accidentally.
21. **Store idle power tools out of the reach of children and do not allow persons unfamiliar with the power tool or these instructions to**

**operate the power tool.** Power tools are dangerous in the hands of untrained users.

22. **Maintain power tools. Check for misalignment or binding of moving parts, breakage of parts and any other condition that may affect the power tool's operation. If damaged, have the power tool repaired before use.** Many accidents are caused by poorly maintained power tools.
23. **Keep cutting tools sharp and clean.** Properly maintained cutting tools with sharp cutting edges are less likely to bind and are easier to control.
24. **Use the power tool, accessories and tool bits etc. in accordance with these instructions, taking into account the working conditions and the work to be performed.** Use of the power tool for operations different from those intended could result in a hazardous situation.

#### Service

25. **Have your power tool serviced by a qualified repair person using only identical replacement parts.** This will ensure that the safety of the power tool is maintained.
26. **Follow instruction for lubricating and changing accessories.**
27. **Keep handles dry, clean and free from oil and grease.**

GEB017-4

## SCREWDRIVER SAFETY WARNINGS

1. **Hold power tool by insulated gripping surfaces, when performing an operation where the fastener may contact hidden wiring or its own cord.** Fasteners contacting a "live" wire may make exposed metal parts of the power tool "live" and could give the operator an electric shock.
2. **Always be sure you have a firm footing. Be sure no one is below when using the tool in high locations.**
3. **Hold the tool firmly.**
4. **Keep hands away from rotating parts.**
5. **Do not touch the bit or the workpiece immediately after operation; they may be extremely hot and could burn your skin.**

## SAVE THESE INSTRUCTIONS.

### WARNING:

**DO NOT** let comfort or familiarity with product (gained from repeated use) replace strict adherence to safety rules for the subject product. **MISUSE** or failure to follow the safety rules stated in this instruction manual may cause serious personal injury.

## FUNCTIONAL DESCRIPTION

### ⚠CAUTION:

- Always be sure that the tool is switched off and unplugged before adjusting or checking function on the tool.

### Depth adjustment

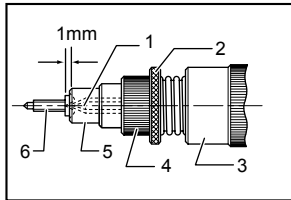

1. Bit
2. Lock ring
3. Clutch cover
4. Front cover
5. Stop ring
6. Self-drilling screw

013634

The depth can be adjusted by turning the front cover. Loosen the lock ring, which locks the front cover, by turning it clockwise.

Turn the front cover so that the screw head protrudes approximately 1 mm from the stop ring.

After adjusting the front cover, tighten the lock ring firmly against the front cover so that the front cover does not move.

Drive a trial screw into your material or a piece of duplicate material. If the depth is not suitable for the screw, continue adjusting until the proper depth setting is obtained.

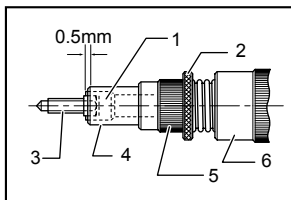

1. Socket bit
2. Lock ring
3. Hex bolt
4. Stop ring
5. Front cover
6. Clutch cover

013635

When using a socket bit, turn the front cover so that the hex bolt head protrudes approximately 0.5 mm from the stop ring.

### Switch action

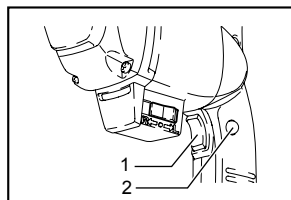

1. Switch trigger
2. Lock button

013638

### ⚠CAUTION:

- Before plugging in the tool, always check to see that the switch trigger actuates properly and returns to the "OFF" position when released.

To start the tool, simply pull the switch trigger. Release the switch trigger to stop.

For continuous operation, pull the switch trigger and then push in the lock button.

To stop the tool from the locked position, pull the switch trigger fully, then release it.

### NOTE:

- Even with the switch on and motor running, the bit does not rotate until you fit the point of the bit in the screw head and apply forward pressure to engage the clutch.

### Reversing switch action

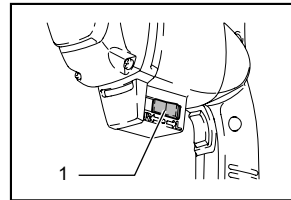

1. Reversing switch

013636

### ⚠CAUTION:

- Always check the direction of rotation before operation.
- Use the reversing switch only after the tool comes to a complete stop. Changing the direction of rotation before the tool stops may damage the tool.

This tool has a reversing switch to change the direction of rotation. Press the "R" side of the reversing switch for clockwise rotation, and or the "L" side for counterclockwise rotation.

## ASSEMBLY

### ⚠CAUTION:

- Always be sure that the tool is switched off and unplugged before carrying out any work on the tool.

### Removing or installing the bit

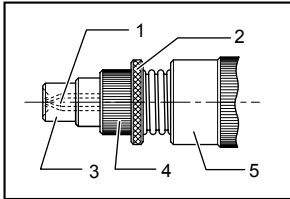

013633

To remove the bit, pull off the stop ring and the bit firmly. To install the bit, insert the bit into the tool as far as it goes. Then return the stop ring.

## OPERATION

### ⚠CAUTION:

- When fitting the screw onto the point of the bit, be careful not to push in on the screw. If the screw is pushed in, the clutch engages and the screw rotates suddenly. This may cause an injury or damage a workpiece.

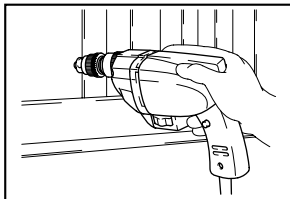

013637

Fit the screw on the point of the bit and place the point of the screw on the surface of the workpiece to be fastened. Apply pressure to the tool and start it. Withdraw the tool as soon as the clutch cuts in. Then release the switch trigger.

### ⚠CAUTION:

- Make sure that the bit is inserted straight in the screw head, or the screw and/or bit may be damaged.
- Use the proper bit for the head of the screw that you wish to use.
- Do not continue unnecessary clutching operation.

## MAINTENANCE

### ⚠CAUTION:

- Always be sure that the tool is switched off and unplugged before attempting to perform inspection or maintenance.
- Never use gasoline, benzene, thinner, alcohol or the like. Discoloration, deformation or cracks may result.

To maintain product SAFETY and RELIABILITY, repairs, carbon brush inspection and replacement, any other maintenance or adjustment should be performed by Makita Authorized Service Centers, always using Makita replacement parts.

## OPTIONAL ACCESSORIES

### ⚠CAUTION:

- These accessories or attachments are recommended for use with your Makita tool specified in this manual. The use of any other accessories or attachments might present a risk of injury to persons. Only use the accessories or attachments for their stated purposes.

If you need any assistance for more details regarding these accessories, ask your local Makita Service Center.

- Phillips bits
- Socket bits
- Stop ring (for socket bit)
- Steel carrying case

### NOTE:

- Some items in the list may be included in the tool package as standard accessories. They may differ from country to country.





Makita Corporation