

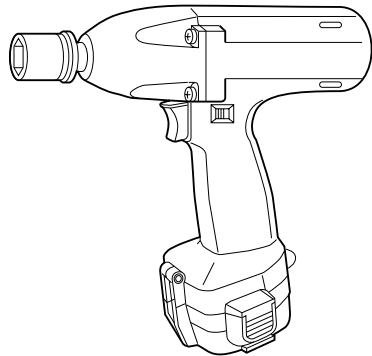

Cordless Impact Wrench

MODEL 6915D



005360

I N S T R U C T I O N M A N U A L

⚠ WARNING:

For your personal safety, READ and UNDERSTAND before using.
SAVE THESE INSTRUCTIONS FOR FUTURE REFERENCE.

SPECIFICATIONS

Model		6915D
Capacities	Standard bolt	M8 - M14
	High tensile bolt	M6 - M12
Square drive		12.7 mm
No load speed (min ⁻¹)		0 - 1,800
Impacts per minute		0 - 2,500
Max. fastening torque		117 N.m
Overall length		221 mm
Net weight		1.9 kg
Rated voltage		D.C. 12 V

- Due to our continuing programme of research and development, the specifications herein are subject to change without notice.
- Note: Specifications may differ from country to country.

Intended use

The tool is intended for fastening bolts and nuts.

For European countries only

Noise and Vibration

The typical A-weighted noise levels are
 sound pressure level: 93 dB (A)
 sound power level: 106 dB (A)

– Wear ear protection. –

The typical weighted root mean square acceleration value is 6 m/s².

EC-DECLARATION OF CONFORMITY

We declare under our sole responsibility that this product is in compliance with the following standards of standardized documents, EN50260, EN55014 in accordance with Council Directives, 89/336/EEC, 98/37/EC.

Yasuhiko Kanzaki **CE 2004**



Director

MAKITA INTERNATIONAL EUROPE LTD.

Michigan Drive, Tongwell, Milton Keynes, Bucks MK15 8JD, ENGLAND

SAFETY INSTRUCTIONS

ENA002-2

WARNING:

When using battery operated tools basic safety precautions, including the following, should be followed to reduce the risk of fire, leaking batteries and personal injury: Read these instructions before operating this product and save these instructions.

For safe operations:

- 1. Keep work area clean.**
Cluttered areas and benches invite injuries.
- 2. Consider the work environment.**
Do not expose the tool to rain. Keep work area well lit. Do not use tools in the presence of flammable liquids or gases.
- 3. Keep children away.**
Do not let visitors touch the tool. Keep visitors away from work area.
- 4. Store batteries or idle tools.**
When not in use, tools and batteries should be stored separately in a dry, high or locked up place, out of reach of children.
Ensure that battery terminals cannot be shorted by other metal parts such as screws, nails, etc.
- 5. Do not force the tool.**
It will do the job better and safer at the rate for which it was intended.
- 6. Use the right tool.**
Do not force small tools or attachments to do the job of a heavy duty tool. Do not use tools for purposes not intended.
- 7. Dress properly.**
Do not wear loose clothing or jewellery, they can be caught in moving parts. Non-skid footwear is recommended when working outdoors. Wear protecting hair covering to contain long hair.
- 8. Use protective equipment.**
Use safety glasses and if the cutting operation is dusty, a face or dust mask.
- 9. Connect dust extraction equipment.**
If devices are provided for the connection of dust extraction and collection ensure these are connected and properly used.
- 10. Do not abuse the supply cord (if fitted).**
Never carry the tool by the cord or yank it to disconnect from the socket. Keep the cord away from heat, oil and sharp edges.
- 11. Secure the work.**
Use clamps or a vice to hold the work. It is safer than using your hand and it frees both hands to operate the tool.
- 12. Do not over-reach.**
Keep proper footing and balance at all times.
- 13. Maintain tools with care.**
Keep cutting tools sharp and clean for better and safer performance. Follow instructions for lubrication and changing accessories. Inspect tool cords periodically and if damaged have repaired by an authorized service facility.
- 14. Disconnect tools.**
Where the design permits, disconnect the tool from its battery pack when not in use, before servicing and when changing accessories such as blades, bits and cutters.
- 15. Remove adjusting keys and wrenches.**
Form the habit of checking to see that keys and adjusting wrenches are removed from the tool before turning it on.
- 16. Avoid unintentional starting.**
Do not carry the tool with a finger on the switch.
- 17. Stay alert.**
Watch what you are doing. Use common sense. Do not operate the tool when you are tired.
- 18. Check damaged parts.**
Before further use of the tool, a guard or other part that is damaged should be carefully checked to determine that it will operate properly and perform its intended function. Check for alignment of moving parts, free running of moving parts, breakage of parts, mounting and any other condition that may affect its operation. A guard or other part that is damaged should be properly repaired or replaced by an authorized service facility unless otherwise indicated in this instruction manual. Have defective switches replaced by an authorized service facility. Do not use the tool if the switch does not turn it on and off.
- 19. Warning.**
The use of any accessory or attachment, other than recommended in this instruction manual or the catalog, may present a risk of personal injury.
Ensure that the battery pack is correct for the tool.
Ensure that the outside surface of battery pack or tool is clean and dry before plugging into charger.
Ensure that batteries are charged using the correct charger recommended by the manufacturer. Incorrect use may result in a risk of electric shock, overheating or leakage of corrosive liquid from the battery.
- 20. Have your tool repaired by a qualified person.**
This tool is constructed in accordance with the relevant safety requirements. Repairs should only be carried out by qualified persons using original spare parts, otherwise this may result in considerable danger to the user.
- 21. Disposal of battery.**
Ensure battery is disposed of safely as instructed by the manufacturer.

ADDITIONAL SAFETY RULES FOR TOOL

ENB025-1

1. Be aware that this tool is always in an operating condition, because it does not have to be plugged into an electrical outlet.
2. Hold tool by insulated gripping surfaces when performing an operation where the cutting tool may contact hidden wiring. Contact with a "live" wire will also make exposed metal parts of the tool "live" and shock the operator.
3. Wear ear protectors.
4. Check the socket carefully for wear, cracks or damage before installation.
5. Hold the tool firmly.
6. Always be sure you have a firm footing.
7. Be sure no one is below when using the tool in high locations.
8. The proper fastening torque may differ depending upon the kind or size of the bolt. Check the torque with a torque wrench.

SAVE THESE INSTRUCTIONS

IMPORTANT SAFETY INSTRUCTIONS FOR BATTERY CARTRIDGE

ENC004-1

1. Before using battery cartridge, read all instructions and cautionary markings on (1) battery charger, (2) battery, and (3) product using battery.
2. Do not disassemble battery cartridge.
3. If operating time has become excessively shorter, stop operating immediately. It may result in a risk of overheating, possible burns and even an explosion.
4. If electrolyte gets into your eyes, rinse them out with clear water and seek medical attention right away. It may result in loss of your eyesight.
5. Always cover the battery terminals with the battery cover when the battery cartridge is not used.
6. Do not short the battery cartridge:
 - (1) Do not touch the terminals with any conductive material.
 - (2) Avoid storing battery cartridge in a container with other metal objects such as nails, coins, etc.
 - (3) Do not expose battery cartridge to water or rain.

A battery short can cause a large current flow, overheating, possible burns and even a breakdown.
7. Do not store the tool and battery cartridge in locations where the temperature may reach or exceed 50°C (122°F).
8. Do not incinerate the battery cartridge even if it is severely damaged or is completely worn out. The battery cartridge can explode in a fire.
9. Be careful not to drop or strike battery.

SAVE THESE INSTRUCTIONS

Tips for maintaining maximum battery life

1. Charge the battery cartridge before completely discharged.
Always stop tool operation and charge the battery cartridge when you notice less tool power.
2. Never recharge a fully charged battery cartridge. Overcharging shortens the battery service life.
3. Charge the battery cartridge with room temperature at 10°C - 40°C (50°F - 104°F). Let a hot battery cartridge cool down before charging it.
4. Charge the Nickel Metal Hydride battery cartridge when you do not use it for more than six months.

FUNCTIONAL DESCRIPTION

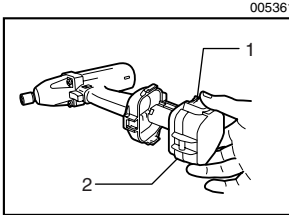

1. Button
2. Battery cartridge

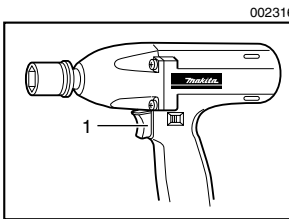

1. Switch trigger

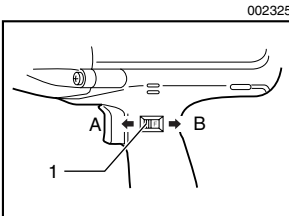

1. Reversing switch

ASSEMBLY

⚠ CAUTION:

- Always be sure that the tool is switched off and the battery cartridge is removed before adjusting or checking function on the tool.

Installing or removing battery cartridge

- Always switch off the tool before installation or removal of the battery cartridge.
- To remove the battery cartridge, withdraw it from the tool while pushing the buttons on both sides of the battery cartridge.
- To insert the battery cartridge, align the tongue on the battery cartridge with the groove in the housing and slip it into place. Always insert it all the way until it locks in place with a little click. If not, it may accidentally fall out of the tool, causing injury to you or someone around you.
- Do not use force when inserting the battery cartridge. If the cartridge does not slide in easily, it is not being inserted correctly.

Switch action

⚠ CAUTION:

- Before inserting the battery cartridge into the tool, always check to see that the switch trigger actuates properly and returns to the "OFF" position when released.

To start the tool, simply pull the switch trigger. Tool speed is increased by increasing pressure on the switch trigger. Release the switch trigger to stop.

Reversing switch action

This tool has a reversing switch to change the direction of rotation. Slide the reversing switch to the A side (appear "F" marking) for clockwise rotation or to the B side (appear "R" marking) for counterclockwise rotation.

⚠ CAUTION:

- Always check the direction of rotation before operation.
- Use the reversing switch only after the tool comes to a complete stop. Changing the direction of rotation before the tool stops may damage the tool.

⚠ CAUTION:

- Always be sure that the tool is switched off and the battery cartridge is removed before carrying out any work on the tool.

Selecting correct socket

Always use the correct size socket for bolts and nuts. An incorrect size socket will result in inaccurate and inconsistent fastening torque and/or damage to the bolt or nut.

005362

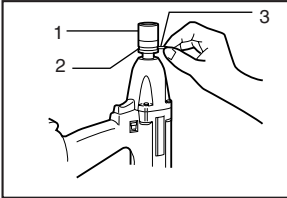

1. Socket
2. O-ring
3. Pin

Installing or removing socket

Move the O-ring out of the groove in the socket and remove the pin from the socket. Fit the socket onto the anvil of the tool so that the hole in the socket is aligned with the hole in the anvil. Insert the pin through the hole in the socket and anvil. Then return the O-ring to the original position in the socket groove to retain the pin. To remove the socket, follow the installation procedures in reverse.

OPERATION

005363

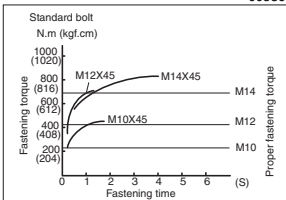

The proper fastening torque may differ depending upon the kind or size of the bolt, the material of the workpiece to be fastened, etc. The relation between fastening torque and fastening time is shown in the figures.

Hold the tool firmly and place the socket over the bolt or nut. Turn the tool on and fasten for the proper fastening time.

NOTE:

- When fastening screw M8 or smaller, carefully adjust pressure on the switch trigger so that the screw is not damaged.
- Hold the tool pointed straight at the bolt or nut.
- Excessive fastening torque may damage the bolt/nut or socket. Before starting your job, always perform a test operation to determine the proper fastening time for your bolt or nut. Especially for the bolt smaller than M8, perform the above test operation to prevent the trouble on socket or bolt, etc.
- If the tool is operated continuously until the battery cartridge has discharged, allow the tool to rest for 15 minutes before proceeding with a fresh battery cartridge.

005364

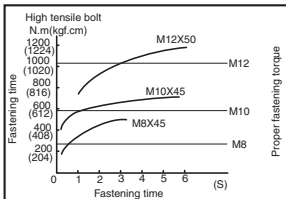

The fastening time is affected by a wide variety of factors including the following. After fastening, always check the torque with a torque wrench.

1. When the battery cartridge is discharged almost completely, voltage will drop and the fastening torque will be reduced.
2. Socket
 - Failure to use the correct size socket will cause a reduction in the fastening torque.
 - A worn socket (wear on the hex end or square end) will cause a reduction in the fastening torque.
3. Bolt
 - Even though the torque coefficient and the class of bolt are the same, the proper fastening torque will differ according to the diameter of bolt.
 - Even though the diameters of bolts are the same, the proper fastening torque will differ according to the torque coefficient, the class of bolt and the bolt length.
4. The use of the universal joint or the extension bar somewhat reduces the fastening force of the impact wrench. Compensate by fastening for a longer period of time.
5. The manner of holding the tool or the material of driving position to be fastened will affect the torque.
6. Operating the tool at low speed will cause a reduction in the fastening torque.

MAINTENANCE

 **CAUTION:**

- Always be sure that the tool is switched off and the battery cartridge is removed before attempting to perform inspection or maintenance.

To maintain product SAFETY and RELIABILITY, repairs, any other maintenance or adjustment should be performed by Makita Authorized Service Centers, always using Makita replacement parts.

ACCESSORIES

 **CAUTION:**

- These accessories or attachments are recommended for use with your Makita tool specified in this manual. The use of any other accessories or attachments might present a risk of injury to persons. Only use accessory or attachment for its stated purpose.

If you need any assistance for more details regarding these accessories, ask your local Makita service center.

- Sockets
- Extension bar
- Universal joint
- Bit adapter
- Phillips bits
- Various type of Makita genuine batteries and chargers

Makita Corporation