



ENGLISH (Original Instructions)

INSTRUCTION MANUAL

Sharpener

9820-2

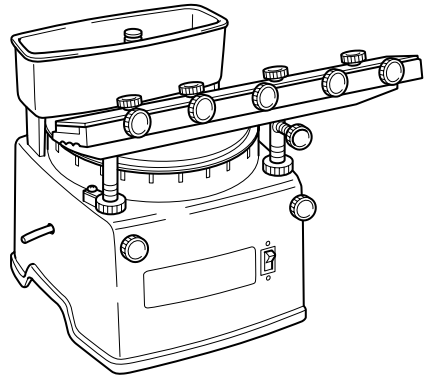

007269

IMPORTANT: Read Before Using.

ENGLISH (Original instructions)

SPECIFICATIONS

Model	9820-2		
Wheel size	200 mm x 25 mm x 75 mm		
No load speed (RPM)	Hz	50	460
		60	560
Overall length	360 mm		
Net weight	8.5 kg		
Safety class	Class I		

- Due to our continuing program of research and development, the specifications herein are subject to change without notice.
- Specifications may differ from country to country.

END224-1

Symbols

The following show the symbols used for the equipment. Be sure that you understand their meaning before use.



• Read instruction manual.

• Only for EU countries

Do not dispose of electric equipment together with household waste material!

In observance of European Directive 2002/96/EC on waste electric and electronic equipment and its implementation in accordance with national law, electric equipment that have reached the end of their life must be collected separately and returned to an environmentally compatible recycling facility.

ENE083-1

Intended use

This tool is intended for sharpening blade.

ENF001-1

Power supply

The tool should be connected only to a power supply of the same voltage as indicated on the nameplate, and can only be operated on single-phase AC supply. This tool should be grounded while in use to protect the operator from electric shock. Use only three-wire extension cords which have three-prong grounding-type plugs and three-pole receptacles which accept the tool's plug.

ENA001-2

SAFETY INSTRUCTIONS

WARNING! When using electric tools, basic safety precautions, including the following, should always be followed to reduce the risk of fire, electric shock and personal injury. Read all these instructions before operating this product and save these instructions.

For safe operations:

1. **Keep work area clean.**
Cluttered areas and benches invite injuries.
2. **Consider work area environment.**
Do not expose power tools to rain. Do not use power tools in damp or wet locations. Keep work area well lit. Do not use power tools where there is risk to cause fire or explosion.
3. **Guard against electric shock.**
Avoid body contact with earthed or grounded surfaces (e.g. pipes, radiators, ranges, refrigerators).
4. **Keep children away.**
Do not let visitors touch the tool or extension cord. All visitors should be kept away from work area.
5. **Store idle tools.**
When not in use, tools should be stored in a dry, high or locked up place, out of reach of children.
6. **Do not force the tool.**
It will do the job better and safer at the rate for which it was intended.
7. **Use the right tool.**
Do not force small tools or attachments to do the job of a heavy duty tool. Do not use tools for purposes not intended; for example, do not use circular saws to cut tree limbs or logs.
8. **Dress properly.**
Do not wear loose clothing or jewellery, they can be caught in moving parts. Rubber gloves and non-skid footwear are recommended when working outdoors. Wear protecting hair covering to contain long hair.
9. **Use safety glasses and hearing protection.**
Also use face or dust mask if the cutting operation is dusty.
10. **Connect dust extraction equipment.**
If devices are provided for the connection of dust extraction and collection facilities ensure these are connected and properly used.

11. **Do not abuse the cord.**
Never carry the tool by the cord or yank it to disconnect it from the socket. Keep the cord away from heat, oil and sharp edges.
12. **Secure work.**
Use clamps or a vice to hold the work. It is safer than using your hand and it frees both hands to operate the tool.
13. **Do not overreach.**
Keep proper footing and balance at all times.
14. **Maintain tools with care.**
Keep cutting tools sharp and clean for better and safer performance. Follow instructions for lubrication and changing accessories. Inspect tool cord periodically and if damaged have it repaired by an authorized service facility. Inspect extension cords periodically and replace, if damaged. Keep handles dry, clean and free from oil and grease.
15. **Disconnect tools.**
When not in use, before servicing and when changing accessories such as blades, bits and cutters.
16. **Remove adjusting keys and wrenches.**
Form the habit of checking to see that keys and adjusting wrenches are removed from the tool before turning it on.
17. **Avoid unintentional starting.**
Do not carry a plugged-in tool with a finger on the switch. Ensure switch is off when plugging in.
18. **Use outdoor extension leads.**
When tool is used outdoors, use only extension cords intended for outdoor use.
19. **Stay alert.**
Watch what you are doing. Use common sense. Do not operate tool when you are tired.
20. **Check damaged parts.**
Before further use of the tool, a guard or other part that is damaged should be carefully checked to determine that it will operate properly and perform its intended function. Check for alignment of moving parts, free running of moving parts, breakage of parts, mounting and any other conditions that may affect its operation. A guard or other part that is damaged should be properly repaired or replaced by an authorized service center unless otherwise indicated in this instruction manual. Have defective switches replaced by an authorized service facility. Do not use the tool if the switch does not turn it on and off.
21. **Warning.**
The use of any accessory or attachment, other than those recommended in this instruction manual or the catalog, may present a risk of

personal injury.

22. **Have your tool repaired by a qualified person.**
This electric tool is in accordance with the relevant safety requirements. Repairs should only be carried out by qualified persons using original spare parts, otherwise this may result in considerable danger to the user.

GEB103-1

SHARPENER SAFETY WARNINGS

1. **Wear eye protection.**
2. **Always use guards and eye shields.**
3. **Use only wheels having a maximum operating speed at least as high as "No Load RPM" marked on the tool's nameplate.**
4. **Check the wheel carefully for cracks or damage before operation. Replace cracked or damaged wheel immediately.**
5. **Secure the wheel carefully.**
6. **Be careful not to damage the spindle or the bolt, or the wheel itself might break.**
7. **Keep a space of 5 mm (3/16") between the sharpening platform guide (rail) and the grinding wheel.**
8. **Keep hands away from rotating parts.**
9. **Make sure the workpiece is not contacting the wheel before the switch is turned on.**
10. **Before using the tool on an actual workpiece, let it run for several minutes. Watch for flutter that might be caused by incorrect installation or a poorly balanced wheel.**
11. **Use the upper surface of the wheel only. Do not use the side surface.**
12. **If the wheel stops during operation, makes an odd noise or begins to vibrate, switch off the tool immediately.**
13. **Always switch off and wait for the wheel to come to a complete stop before adjustment or inspection.**
14. **Do not touch the workpiece immediately after operation; it may be extremely hot and could burn your skin.**
15. **Dry the wheel by idling the tool after operation to prevent the wheel from freezing in cold weather. Freezing can crack the wheel.**
16. **Store wheels in a dry location only.**
17. **Do not overtighten wheel nut.**
18. **Use only flanges furnished with this tool.**

SAVE THESE INSTRUCTIONS.

⚠WARNING:

DO NOT let comfort or familiarity with product (gained from repeated use) replace strict adherence to safety rules for the subject product.

MISUSE or failure to follow the safety rules stated in this instruction manual may cause serious personal injury.

FUNCTIONAL DESCRIPTION

⚠CAUTION:

- Always be sure that the tool is switched off and unplugged before adjusting or checking function on the tool.

Switch action

⚠CAUTION:

- Before plugging in the tool, always check to see that the tool is switched off.

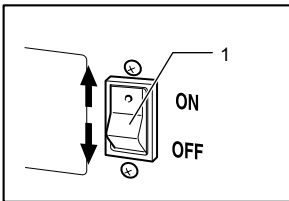

1. Switch

007285

To start the tool, press the "ON" side of the switch located on the front of the tool. To stop the tool, press the "OFF" side of the switch.

ASSEMBLY

⚠CAUTION:

- Always be sure that the tool is switched off and unplugged before carrying out any work on the tool.

Replacing grinding wheel

Use the wrench provided to release the grinding wheel by turning the installation screw counterclockwise.

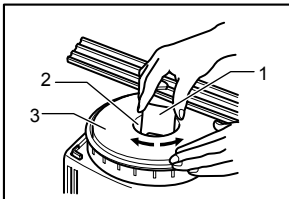

1. Wrench
2. Grinding wheel installation screw
3. Wheel

007270

To install the grinding wheel, follow the removal procedure in reverse.

Adjusting wheel guard

The top of the wheel guard should be 1 mm below the surface of the grinding wheel. Adjust height by turning the guard clockwise to lower it, or counterclockwise to raise it.

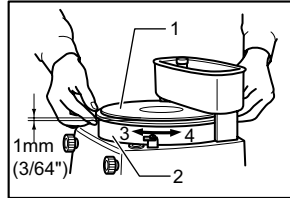

1. Grinding wheel
2. Wheel guard
3. Lower
4. Raise

007271

Wiping off the antirust

Wipe off the antirust on the sharpening platform guide (rail) and the sharpening holder. Coat the sharpening platform guide and the sharpening holder with machine oil or spindle oil.

Removing or installing sharpening platform guide

To remove the sharpening platform guide, loosen the screw and slip the set plate aside.

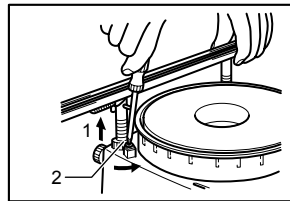

1. Slip aside
2. Set plate

007272

Loosen the pole fastening screws counterclockwise and lift off the sharpening platform guide.

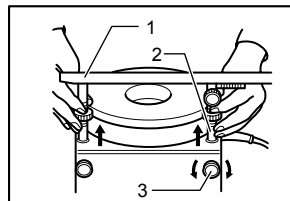

1. Sharpening platform guide (Rail)
2. Pole fastening screw
3. Pole fastening screw

007273

To install the sharpening platform guide, follow the removal procedure in reverse.

Adjusting sharpening platform guide

In using the sharpening platform guide to sharpen blade/knife, adjust the angle adjustment screw to the desired blade/knife sharpening angle. The bevel becomes acute as the angle adjustment screw is turned clockwise.

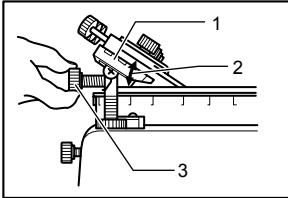

007274

The pole fastening screws fix the platform poles in place. Loosen the pole fastening screws counterclockwise a bit to adjust the height of platform poles.

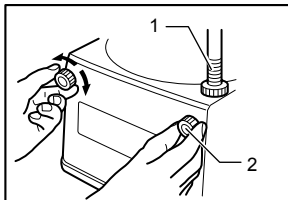

007275

The nut for raising or lowering the pole on either side raises the pole 0.5 mm for each graduation, when turned clockwise, and it lowers the pole, conversely, 0.5 mm when turned counterclockwise.

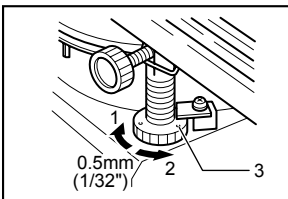

007276

Tilt the sharpening platform guide slightly with right side downward so that the blade contacts the right side surface of the grinding wheel.

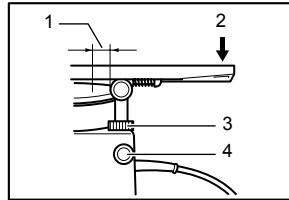

007277

Fasten the pole fastening screws clockwise to fix the platform poles.

Adjusting sharpening holder

The sharpening holder horizontal (forward) adjust screws should be unscrewed to allow the heel of the blade to be inserted so as to contact the blade fastening screws. Then lightly tighten the blade fastening screws and set the holder on the platform.

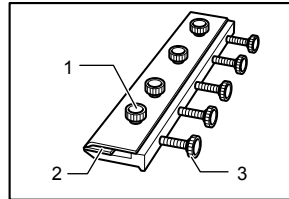

007278

Screw in clockwise the forward adjust screw on the right until the right upper edge of the blade comes into contact with the grinding wheel. Then fully tighten the fastening screw on the far right.

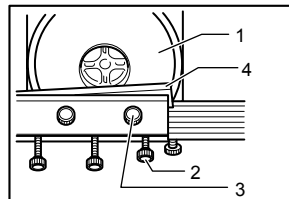

007279

Slide the holder to the right across the sharpening platform guide. Screw in the left-hand forward adjust screw until the left upper edge of the blade contacts the grinding wheel. Now use all four fastening screws to secure the blade on the horizontal.

1. Sharpening platform guide (Rail)
2. Blade/knife sharpening angle
3. Angle adjustment screw

1. Sharpen here
2. Tilt slightly downward
3. Sharpening guide vertical adjustment nut
4. Pole fastening screw

1. Pole
2. Pole fastening screw

1. Blade fastening screw
2. Planer blade
3. Forward adjust screw

1. Raising
2. Lowering
3. Graduation

1. Wheel
2. Right-hand (forward) adjust screw
3. Right-hand fastening screw
4. Planer blade

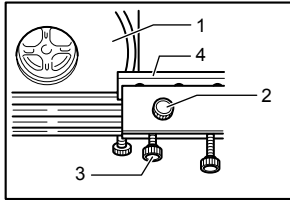

1. Wheel
2. Left-hand fastening screw
3. Left-hand (forward) adjust screw
4. Planer blade

007280

Installing coolant reservoir (Tank)

Insert the reservoir legs into the grooves provided for them on the sharpener frame.

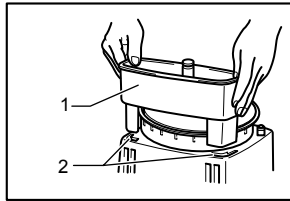

1. Coolant reservoir (Tank)
2. Grooves

007281

Adjusting coolant flow

Put water in the coolant reservoir. Turn the knob so that the marking is positioned vertically to make the coolant flow.

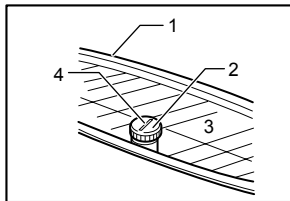

1. Coolant reservoir (Tank)
2. Knob
3. Water
4. Marking

007282

Turn the marking to the horizontal position to stop the coolant flow.

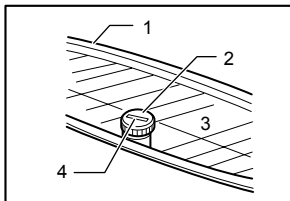

1. Coolant reservoir (Tank)
2. Knob
3. Water
4. Marking

007283

NOTE:

- Adjust the coolant flow adequately. If the debris from the grinding wheel and the blade is washed away by the coolant, the coolant flow is excessive.

Draining used coolant

The used coolant drains out through the drain hose (vinyl tube) provided. Have a pan or drain system ready to catch it.

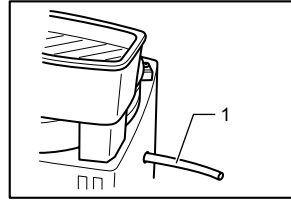

1. Drain hose (Vinyl tube)

007284

OPERATION

Sharpening blade/knife

After you have established the correct coolant flow, you can begin sharpening. Sharpen with the cutting edge away from you, holding the sharpening holder with both hands. Slide the sharpening holder back and forth on the sharpening platform guide at a speed of about ten times per minute, applying uniform pressure (about 5 kg) on it.

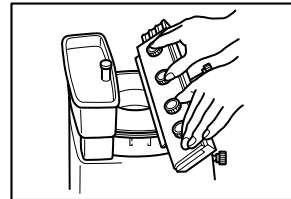

007286

⚠ CAUTION:

- Always use sharpening platform guide or guide assembly (optional accessory) when sharpening blade/knife.

Remove some stock from the tip to the heel in relation to the original grinding angle so as to create a better cutting edge.

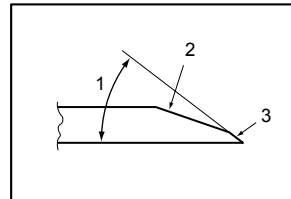

1. Original (proper) grinding angle
2. Take down this area slightly in relation to original angle
3. Tip (correct sharpening angle)

007287

Sharpening power planer blades

Sharpen your planer blades to 40° angle.

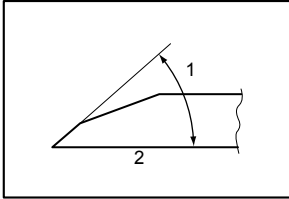

1. Approx. 40°
2. Planer blade

007288

⚠CAUTION:

- Clean and dry the tool after operation.
- Be sure that the tool is switched off, unplugged and drained before attempting to move the tool.

MAINTENANCE

⚠CAUTION:

- Always be sure that the tool is switched off and unplugged before attempting to perform inspection or maintenance.
- Never use gasoline, benzine, thinner, alcohol or the like. Discoloration, deformation or cracks may result.

To maintain product SAFETY and RELIABILITY, repairs, any other maintenance or adjustment should be performed by Makita Authorized Service Centers, always using Makita replacement parts.

OPTIONAL ACCESSORIES

⚠CAUTION:

- These accessories or attachments are recommended for use with your Makita tool specified in this manual. The use of any other accessories or attachments might present a risk of injury to persons. Only use accessory or attachment for its stated purpose.

If you need any assistance for more details regarding these accessories, ask your local Makita Service Center.

- Grinding wheels (#60, #1000, #6000)
- Wrench
- Blade holder assembly
- Guide assembly (sharpening platform guide)

NOTE:

- Some items in the list may be included in the tool package as standard accessories. They may differ from country to country.

Makita Corporation