

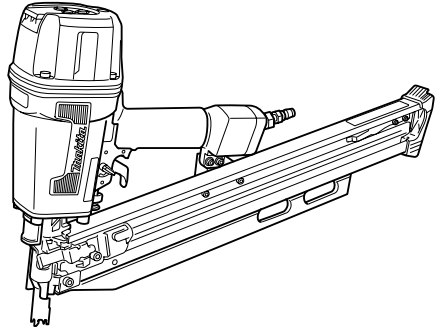

# Pneumatic Framing Nailer

MODEL AN942



004292

## I N S T R U C T I O N M A N U A L

**⚠ WARNING:**

For your personal safety, READ and UNDERSTAND before using.  
SAVE THESE INSTRUCTIONS FOR FUTURE REFERENCE.

---

## SPECIFICATIONS

Model	AN942
Air pressure	0.44 - 0.83 Mpa (4.4 - 8.3 bar)
Nail length	50 mm - 90 mm
Nail capacity	60 - 84 pcs.
Dimensions (L X H X W)	446 mm X 376 mm X 108 mm
Min. hose diameter	8.5 mm
Net weight	3.8 Kg

- Due to our continuing programme of research and development, the specifications herein are subject to change without notice.
- Note: Specifications may differ from country to country.

# IMPORTANT SAFETY INSTRUCTIONS

ENB087-1

## **⚠ WARNING:**

**WHEN USING THIS TOOL, BASIC SAFETY PRECAUTIONS SHOULD ALWAYS BE FOLLOWED TO REDUCE THE RISK OF PERSONAL INJURY, INCLUDING THE FOLLOWING:**

### **READ ALL INSTRUCTIONS.**

- For personal safety and proper operation and maintenance of the tool, read this instruction manual before using the tool.
- Always wear safety glasses and face shield to protect your eyes from dust or nail injury. The safety glasses and the face shield should conform with the requirements of AS/NZS 1336.

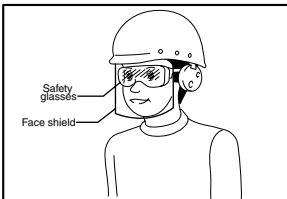

## **⚠ WARNING:**

It is an employer's responsibility to enforce the use of safety eye protection equipment by the tool operators and by other persons in the immediate working area.

- **Wear hearing protection to protect your ears against exhaust noise and head protection. Also wear light but not loose clothing. Sleeves should be buttoned or rolled up. No necktie should be worn.**
- **Rushing the job or forcing the tool is dangerous. Handle the tool carefully. Do not operate when under the influence of alcohol, drugs or the like.**
- **General Tool Handling Guidelines:**
  1. Always assume that the tool contains fasteners.
  2. Do not point the tool toward yourself or anyone whether it contains fasteners or not.
  3. Do not activate the tool unless the tool is placed firmly against the workpiece.
  4. Respect the tool as a working implement.
  5. No horseplay.
  6. Do not hold or carry the tool with a finger on the trigger.
  7. Do not load the tool with fasteners when any one of the operating controls is activated.
  8. Do not operate the tool with any power source other than that specified in the tool operating/safety instructions.
- An improperly functioning tool must not be used.
- Sparks sometimes fly when the tool is used. Do not use the tool near volatile, flammable materials such as gasoline, thinner, paint, gas, adhesives, etc.; they will ignite and explode, causing serious injury.
- The area should be sufficiently illuminated to assure safe operations. The area should be clear and litter-free. Be especially careful to maintain good footing and balance.
- Only those involved in the work should be in the vicinity. Children especially must be kept away at all times.
- There may be local regulations concerning noise which must be complied with by keeping noise levels within prescribed limits. In certain cases, shutters should be used to contain noise.
- Do not play with the contact element: it prevents accidental discharge, so it must be kept on and not removed. Securing the trigger in the ON position is also very dangerous. Never attempt to fasten the trigger. Do not operate a tool if any portion of the tool operating controls is inoperable, disconnected, altered, or not working properly.
- Operate the tool within the specified air pressure of 0.44 - 0.83 MPa (4.4 - 8.3 bar) for safety and longer tool life. Do not exceed the recommended max. operating pressure of 0.83 MPa (8.3 bar). The tool should not be connected to a source whose pressure potentially exceeds 1.37 MPa (13.7 bar).
- Make sure that the pressure supplied by the compressed air system does not exceed the maximum allowable pressure of the fastener driving tool. Set the air pressure initially to the lower value of the recommended allowable pressure (see SPECIFICATIONS).
- Never use the tool with other than compressed air. If bottled gas (carbon dioxide, oxygen, nitrogen, hydrogen, air, etc.) or combustible gas (hydrogen, propane, acetylene, etc.) is used as a power source for this tool, the tool will explode and cause serious injury.

- Always check the tool for its overall condition and loose screws before operation. Tighten as required.
- Make sure all safety systems are in working order before operation. The tool must not operate if only the trigger is pulled or if only the contact arm is pressed against the wood. It must work only when both actions are performed. Test for possible faulty operation with nails unloaded and the pusher in fully pulled position.
- Make sure that the trigger is locked when the change lever is set to the LOCK position.
- Check walls, ceilings, floors, roofing and the like carefully to avoid possible electrical shock, gas leakage, explosions, etc. caused by striking live wires, conduits or gas pipes.
- Use only nails specified in this manual. The use of any other nails may cause malfunction of the tool.
- Never use fastener driving tools marked with the symbol “Do not use on scaffoldings, ladders” for specific application for example:
  - when changing one driving location to another involves the use of scaffoldings, stairs, ladders, or ladder alike constructions, e.g. roof laths; 
  - closing boxes or crates;
  - fitting transportation safety systems e.g. on vehicles and wagons.
- Do not permit those uninstructed to use the tool.
- Make sure no one is nearby before nailing. Never attempt to nail from both the inside and outside at the same time. Nails may rip through and/or fly off, presenting a grave danger.
- Watch your footing and maintain your balance with the tool. Make sure there is no one below when working in high locations, and secure the air hose to prevent danger if there is sudden jerking or catching.
- On rooftops and other high locations, nail as you move forward. It is easy to lose your footing if you nail while inching backward. When nailing against perpendicular surface, nail from the top to the bottom. You can perform nailing operations with less fatigue by doing so.
- A nail will be bent or the tool can become jammed if you mistakenly nail on top of another nail or strike a knot in the wood. The nail may be thrown and hit someone, or the tool itself can react dangerously. Place the nails with care.
- Do not leave the loaded tool or the air compressor under pressure for a long time out in the sun. Be sure that dust, sand, chips and foreign matter will not enter the tool in the place where you leave it setting.
- Do not point the ejection port at anyone in the vicinity. Keep hands and feet away from the ejection port area.
- When the air hose is connected, do not carry the tool with your finger on the trigger or hand it to someone in this condition. Accidental firing can be extremely dangerous.
- Handle the tool carefully, as there is high pressure inside the tool that can be dangerous if a crack is caused by rough handling (dropping or striking). Do not attempt to carve or engrave on the tool.
- Stop nailing operations immediately if you notice something wrong or out of the ordinary with the tool.
- Always disconnect the air hose and remove all of the nails:
  1. When unattended.
  2. Before performing any maintenance or repair.
  3. Before cleaning a jam.
  4. Before moving the tool to a new location.
- Perform cleaning and maintenance right after finishing the job. Keep the tool in tip-top condition. Lubricate moving parts to prevent rusting and minimize friction-related wear. Wipe off all dust from the parts.
- When not operating the tool, always lock the trigger by turning the change lever to the LOCK position.
- Do not operate this tool if it does not contain a legible WARNING LABEL.
- Do not modify tool without authorization from Makita.
- Ask Makita’s Authorized service centers for periodical inspection of the tool.
- To maintain product SAFETY and RELIABILITY, maintenance and repairs should be performed by Makita Authorized Service Centers, always using Makita replacement parts.

**SAVE THESE INSTRUCTIONS**

# INSTALLATION

004293

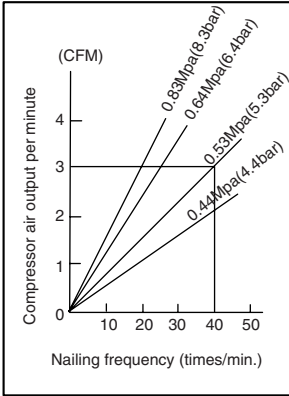

## Selecting compressor

- Select a compressor that has ample pressure and air output to assure cost-efficient operation. The graph shows the relation between nailing frequency, applicable pressure and compressor air output. Thus, for example, if nailing takes place at a rate of approximately 40 times per minute at a compression of 0.59 MPa (5.9 bar), a compressor with an air output over 3 CFM (ft<sup>3</sup>/minute) is required. Pressure regulators must be used to limit air pressure to the rated pressure of the tool where air supply pressure exceeds the tool's rated pressure. Failure to do so may result in serious injury to tool operator or persons in the vicinity.

004294

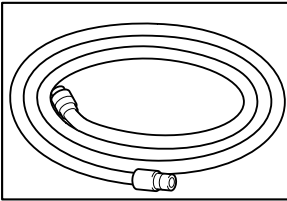

## Selecting air hose

- Use an air hose as large and as short as possible to assure continuous, efficient nailing operation. With an air pressure of 0.49 MPa (4.9 bar), an air hose with an internal diameter of over 8.5 mm (5/16") and a length of less than 20 m (6.6 ft.) is recommended when the interval between each nailing is 0.5 seconds. Air supply hoses shall have a minimum working pressure rating of 1.03 MPa (10.3 bar) or 150 percent of the maximum pressure produced in the system whichever is higher.



### CAUTION:

- Low air output of the compressor, or a long or smaller diameter air hose in relation to the nailing frequency may cause a decrease in the driving capability of the tool.

## Lubrication

004295

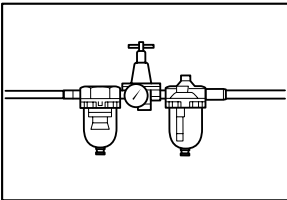

- To insure maximum performance, install an air set (oiler, regulator, air filter) as close as possible to the tool. Adjust the oiler so that one drop of oil will be provided for every 30 nails.

004296

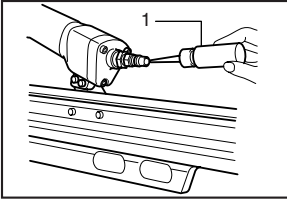

1. Pneumatic tool oil

- When an air set is not used, oil the tool with pneumatic tool oil by placing 2 (two) or 3 (three) drops into the air fitting. This should be done before and after use. For proper lubrication, the tool must be fired a couple of times after pneumatic tool oil is introduced.

## FUNCTIONAL DESCRIPTION

004297

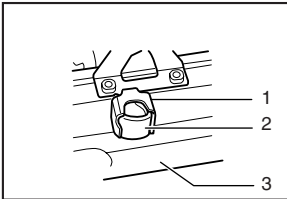

1. Holder
2. Nose adapter
3. Magazine

### Nose adapter

#### ⚠ CAUTION:

- Always lock the trigger and disconnect the hose before installing or removing the nose adapter.
- When nailing workpieces with easily-marred surfaces, use the nose adapter. It is stored in the holder on the reverse side of the magazine.

004298

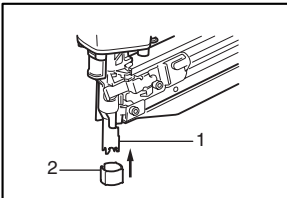

1. Contact arm
2. Nose adapter

- Attach the nose adapter to the contact arm. When not in use, store the nose adapter in the holder on the reverse side of the magazine to keep it from being lost.

### Adjusting depth of nailing

#### ⚠ CAUTION:

- Always lock the trigger and disconnect the hose before adjusting the depth of nailing.

004299

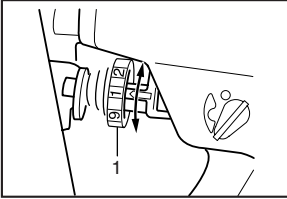

1. Adjuster

- To adjust the depth of nailing, turn the adjuster so that the arrow above the adjuster will point to the number indicated on the adjuster. The depth of nailing is the deepest when the arrow points to the number 1. It will become shallower as the arrow points to higher number. The depth can be changed in approx. 1.0 mm increments per graduation. If nails cannot be driven deep enough even when the arrow points to the number 1, increase the air pressure. If nails are driven too deep even when the arrow points to the number 9, decrease the air pressure. Generally speaking, the tool service life will be longer when the tool is used with lower air pressure and the adjuster set to a lower number.

## ASSEMBLY

### Loading nailer



#### CAUTION:

- Always lock the trigger and disconnect the hose before loading the nailer.
- Select nails suitable for your work. Insert strip of nails into the magazine.

004300

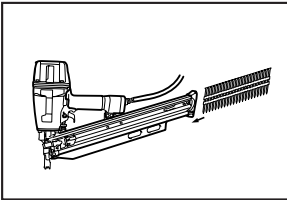

004301

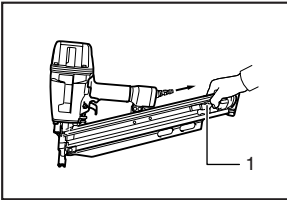

1. Pusher

- Pull the pusher lever to the rear to engage the pusher to the last nail

### Unloading nailer



#### CAUTION:

- Always disconnect the air hose before unloading the nailer.
- Pull the pusher lever to the rear. Return the pusher lever back while keeping the pusher depressed to disengage it from the strip of nails.

004302

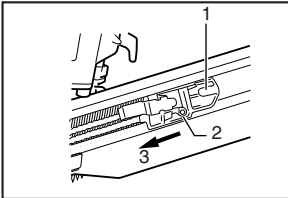

1. Pusher lever
2. Depress
3. Return

004303

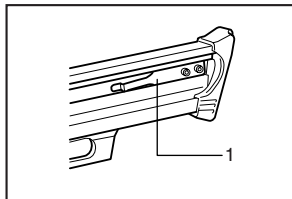

1. Nail stopper

- Depress the nail stopper and remove the strip of nails from the magazine.

004304

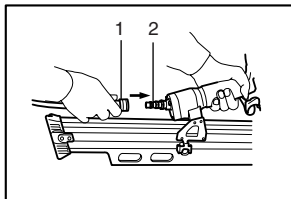

1. Air socket  
2. Air fitting

### Connecting air hose

- Lock the trigger. Slip the air socket of the air hose onto the air fitting on the nailer. Be sure that the air socket locks firmly into position when installed onto the air fitting. A hose coupling must be installed on or near the tool in such a way that the pressure reservoir will discharge at the time the air supply coupling is disconnected.

## OPERATION

### ⚠ CAUTION:

- Make sure all safety systems are in working order before operation.
1. To drive a nail, you may place the contact element against the workpiece and pull the trigger, or
  2. Pull the trigger first and then place the contact element against the workpiece.
- No. 1 method is for intermittent nailing, when you wish to drive a nail carefully and very accurately.  
No. 2 method is for continuous nailing.

004305

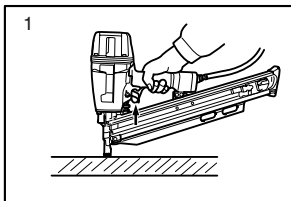

### ⚠ CAUTION:

- However when the tool is set to the "Intermittent Nailing" mode, WITH THE TRIGGER HELD IN A HALF-PULLED POSITION, an unexpected nailing could occur, if contact element is allowed to re-contact against the workpiece or the other surface under the influence of recoil. In order to avoid this unexpected nailing, perform as follows;
- A. Do not place the contact element against the workpiece with excessive force.
  - B. Pull the trigger fully and hold it on for 1-2 seconds after nailing.

004306

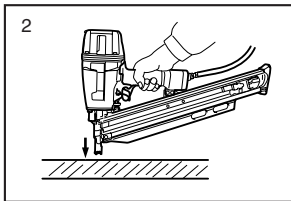



004307

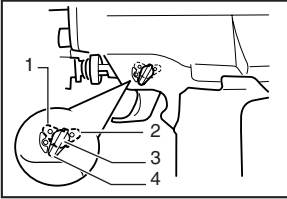

1. Continuous nailing
2. Intermittent nailing
3. Change lever
4. Trigger lock

- For No. 1 method, set the change lever to the “Intermittent Nailing” position. For No. 2 method, set the change lever to the “Continuous Nailing” position. After using the change lever to change the nailing method, always make sure that the change lever is properly set to the position for the desired nailing method.

### Anti dry fire mechanism

- This tool is equipped with an anti dry fire mechanism. When there are a few nails remaining in the magazine, the contact arm will be locked in the undepressed position to prevent the tool from being activated. Load more nails to resume operation.

### Jammed nailer

#### CAUTION:

- Always lock the trigger, disconnect the hose and remove the nails from the magazine before cleaning a jam.
- When the nailer becomes jammed, do as follows:
- Insert a small rod or the like into the ejection port and tap it with a hammer to retract the driver. Use pliers to bend the jammed nail so that the nail head comes out of the slot in the driver guide. Then remove the jammed nail.

004308

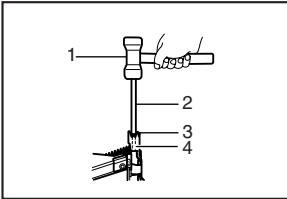

1. Hammer
2. Small rod
3. Ejection port
4. Driver

004309

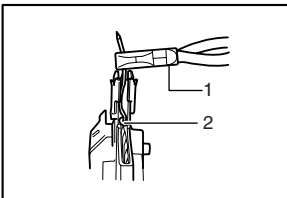

1. Pliers
2. Slot

## Nails

004310

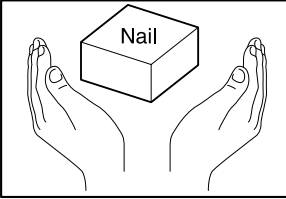

- Handle nail strips and their box carefully. If the nail strips have been handled roughly, they may be out of shape or their connector breaks, causing poor nail feed.

004311

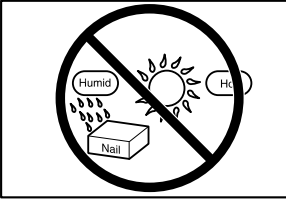

- Avoid storing nails in a very humid or hot place or place exposed to direct sunlight.

## MAINTENANCE



### CAUTION:

- Always disconnect the hose before attempting to perform inspection or maintenance.

### Maintenance of nailer

004312

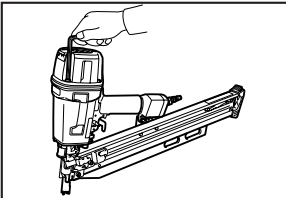

- Always check the tool for its overall condition and loose screws before operation. Tighten as required.

004313

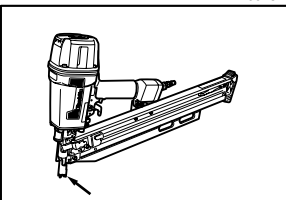

- With tool disconnected, make daily inspection to assure free movement of the contact element and trigger. Do not use tool if the contact element or trigger sticks or binds.

004314

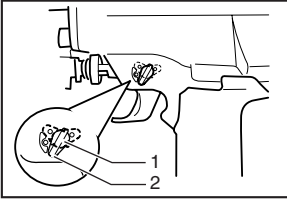

1. Change lever
2. Trigger lock

- Make sure that the trigger is locked when the change lever is set to the LOCK position.

004315

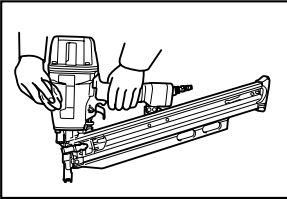

- When the tool is not to be used for an extended period of time, lubricate the tool using pneumatic tool oil and store the tool in a safe place. Avoid exposure to direct sunlight and/or humid or hot environment.

004316

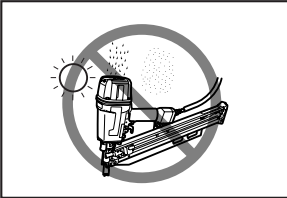

### Maintenance of compressor, air set and air hose

004317

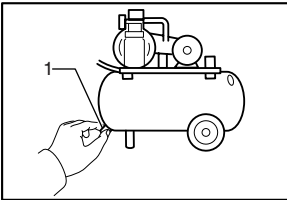

1. Drain cock

- After operation, always drain the compressor tank and the air filter. If moisture is allowed to enter the tool, it may result in poor performance and possible tool failure.

004318

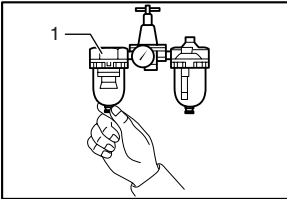

1. Air filter

004319

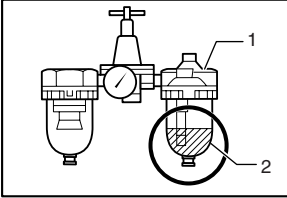

- 1. Oiler
- 2. Pneumatic oil

- Check regularly to see if there is sufficient pneumatic oil in the oiler of the air set. Failure to maintain sufficient lubrication will cause O-rings to wear quickly.

004320



- Keep the air hose away from heat (over 60°C, over 140°F), away from chemicals (thinner, strong acids or alkalis). Also, route the hose away from obstacles which it may become dangerously caught on during operation. Hoses must also be directed away from sharp edges and areas which may lead to damage or abrasion to the hose.

To maintain product SAFETY and RELIABILITY, repairs, any other maintenance and adjustment should be performed by Makita Authorized Service Centers, always using Makita replacement parts.

---

## Memo

---

---

---

---

---

---

---

---

---

---

---

---

---

---

---

---

---

---

---

---

---

---

---

---

## Memo

---

---

---

---

---

---

---

---

---

---

---

---

---

---

---

---

---

---

---

---

---

---

---

---

---

---

## Memo

---

---

---

---

---

---

---

---

---

---

---

---

---

---

---

---

---

Makita Corporation