

INSTRUCTION MANUAL

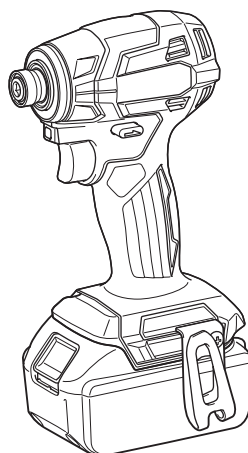

# Cordless Impact Driver

## DTD173



Read before use.

# SPECIFICATIONS

Model:		DTD173
Fastening capacities	Machine screw	M4 - M8
	Standard bolt	M5 - M16
	High tensile bolt	M5 - M14
No load speed	Max impact mode	0 - 3,600 min <sup>-1</sup>
	Hard impact mode	0 - 3,200 min <sup>-1</sup>
	Medium impact mode	0 - 2,100 min <sup>-1</sup>
	Soft impact mode	0 - 1,100 min <sup>-1</sup>
	Wood mode	0 - 1,800 min <sup>-1</sup>
	Bolt mode	0 - 3,600 min <sup>-1</sup>
	T mode (1)	0 - 2,900 min <sup>-1</sup>
	T mode (2)	0 - 3,600 min <sup>-1</sup>
Impacts per minute	Max impact mode	0 - 3,800 min <sup>-1</sup>
	Hard impact mode	0 - 3,600 min <sup>-1</sup>
	Medium impact mode	0 - 2,600 min <sup>-1</sup>
	Soft impact mode	0 - 1,100 min <sup>-1</sup>
	Wood mode	0 - 3,800 min <sup>-1</sup>
	Bolt mode	0 - 3,800 min <sup>-1</sup>
	T mode (1)	-
	T mode (2)	0 - 2,600 min <sup>-1</sup>
Rated voltage		D.C. 18 V
Overall length		111 mm
Net weight		1.2 - 1.5 kg

- Due to our continuing program of research and development, the specifications herein are subject to change without notice.
- Specifications may differ from country to country.
- The weight may differ depending on the attachment(s), including the battery cartridge. The lightest and heaviest combinations, according to EPTA-Procedure 01/2014, are shown in the table.

## Applicable battery cartridge and charger

Battery cartridge	BL1815N / BL1820B / BL1830B / BL1840B / BL1850B / BL1860B
Charger	DC18RC / DC18RD / DC18RE / DC18SE / DC18SF / DC18SH / DC18WC

- Some of the battery cartridges and chargers listed above may not be available depending on your region of residence.

**⚠ WARNING: Only use the battery cartridges and chargers listed above.** Use of any other battery cartridges and chargers may cause injury and/or fire.

## Symbols

The followings show the symbols which may be used for the equipment. Be sure that you understand their meaning before use.



Read instruction manual.



Only for EU countries  
 Due to the presence of hazardous components in the equipment, waste electrical and electronic equipment, accumulators and batteries may have a negative impact on the environment and human health. Do not dispose of electrical and electronic appliances or batteries with household waste! In accordance with the European Directive on waste electrical and electronic equipment and on accumulators and batteries and waste accumulators and batteries, as well as their adaptation to national law, waste electrical equipment, batteries and accumulators should be stored separately and delivered to a separate collection point for municipal waste, operating in accordance with the regulations on environmental protection. This is indicated by the symbol of the crossed-out wheeled bin placed on the equipment.

## Intended use

The tool is intended for screw driving in wood, metal and plastic.

## Noise

The typical A-weighted noise level determined according to EN62841-2-2:

Sound pressure level ( $L_{pA}$ ) : 100 dB (A)

Sound power level ( $L_{WA}$ ) : 108 dB (A)

Uncertainty (K) : 3 dB (A)

**NOTE:** The declared noise emission value(s) has been measured in accordance with a standard test method and may be used for comparing one tool with another.

**NOTE:** The declared noise emission value(s) may also be used in a preliminary assessment of exposure.

**⚠ WARNING: Wear ear protection.**

**⚠ WARNING:** The noise emission during actual use of the power tool can differ from the declared value(s) depending on the ways in which the tool is used especially what kind of workpiece is processed.

**⚠ WARNING:** Be sure to identify safety measures to protect the operator that are based on an estimation of exposure in the actual conditions of use (taking account of all parts of the operating cycle such as the times when the tool is switched off and when it is running idle in addition to the trigger time).

## Vibration

The vibration total value (tri-axial vector sum) determined according to EN62841-2-2:

Work mode: impact tightening of fasteners of the maximum capacity of the tool

Vibration emission ( $a_{hv}$ ) : 12.9 m/s<sup>2</sup>

Uncertainty (K) : 1.5 m/s<sup>2</sup>

**NOTE:** The declared vibration total value(s) has been measured in accordance with a standard test method and may be used for comparing one tool with another.

**NOTE:** The declared vibration total value(s) may also be used in a preliminary assessment of exposure.

**⚠ WARNING:** The vibration emission during actual use of the power tool can differ from the declared value(s) depending on the ways in which the tool is used especially what kind of workpiece is processed.

**⚠ WARNING:** Be sure to identify safety measures to protect the operator that are based on an estimation of exposure in the actual conditions of use (taking account of all parts of the operating cycle such as the times when the tool is switched off and when it is running idle in addition to the trigger time).

## Declarations of Conformity

### For European countries only

The Declarations of conformity are included in Annex A to this instruction manual.

## SAFETY WARNINGS

### General power tool safety warnings

**⚠ WARNING** Read all safety warnings, instructions, illustrations and specifications provided with this power tool. Failure to follow all instructions listed below may result in electric shock, fire and/or serious injury.

### Save all warnings and instructions for future reference.

The term "power tool" in the warnings refers to your mains-operated (corded) power tool or battery-operated (cordless) power tool.

#### Work area safety

1. **Keep work area clean and well lit.** Cluttered or dark areas invite accidents.
2. **Do not operate power tools in explosive atmospheres, such as in the presence of flammable liquids, gases or dust.** Power tools create sparks which may ignite the dust or fumes.
3. **Keep children and bystanders away while operating a power tool.** Distractions can cause you to lose control.

#### Electrical safety

1. **Power tool plugs must match the outlet. Never modify the plug in any way. Do not use any adapter plugs with earthed (grounded) power tools.** Unmodified plugs and matching outlets will reduce risk of electric shock.
2. **Avoid body contact with earthed or grounded surfaces, such as pipes, radiators, ranges and refrigerators.** There is an increased risk of electric shock if your body is earthed or grounded.
3. **Do not expose power tools to rain or wet conditions.** Water entering a power tool will increase the risk of electric shock.
4. **Do not abuse the cord. Never use the cord for carrying, pulling or unplugging the power tool. Keep cord away from heat, oil, sharp edges or moving parts.** Damaged or entangled cords increase the risk of electric shock.
5. **When operating a power tool outdoors, use an extension cord suitable for outdoor use.** Use of a cord suitable for outdoor use reduces the risk of electric shock.
6. **If operating a power tool in a damp location is unavoidable, use a residual current device (RCD) protected supply.** Use of an RCD reduces the risk of electric shock.
7. **Power tools can produce electromagnetic fields (EMF) that are not harmful to the user.** However, users of pacemakers and other similar medical devices should contact the maker of their device and/or doctor for advice before operating this power tool.

## Personal safety

1. **Stay alert, watch what you are doing and use common sense when operating a power tool. Do not use a power tool while you are tired or under the influence of drugs, alcohol or medication.** A moment of inattention while operating power tools may result in serious personal injury.
2. **Use personal protective equipment. Always wear eye protection.** Protective equipment such as a dust mask, non-skid safety shoes, hard hat or hearing protection used for appropriate conditions will reduce personal injuries.
3. **Prevent unintentional starting. Ensure the switch is in the off-position before connecting to power source and/or battery pack, picking up or carrying the tool.** Carrying power tools with your finger on the switch or energising power tools that have the switch on invites accidents.
4. **Remove any adjusting key or wrench before turning the power tool on.** A wrench or a key left attached to a rotating part of the power tool may result in personal injury.
5. **Do not overreach. Keep proper footing and balance at all times.** This enables better control of the power tool in unexpected situations.
6. **Dress properly. Do not wear loose clothing or jewellery. Keep your hair and clothing away from moving parts.** Loose clothes, jewellery or long hair can be caught in moving parts.
7. **If devices are provided for the connection of dust extraction and collection facilities, ensure these are connected and properly used.** Use of dust collection can reduce dust-related hazards.
8. **Do not let familiarity gained from frequent use of tools allow you to become complacent and ignore tool safety principles.** A careless action can cause severe injury within a fraction of a second.
9. **Always wear protective goggles to protect your eyes from injury when using power tools. The goggles must comply with ANSI Z87.1 in the USA, EN 166 in Europe, or AS/NZS 1336 in Australia/New Zealand. In Australia/New Zealand, it is legally required to wear a face shield to protect your face, too.**

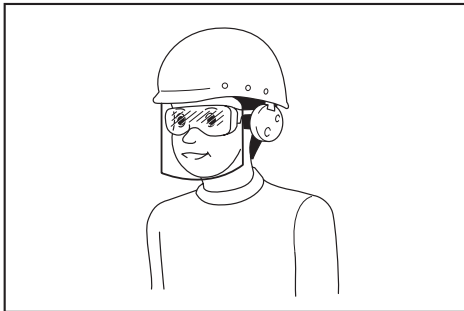

It is an employer's responsibility to enforce the use of appropriate safety protective equipments by the tool operators and by other persons in the immediate working area.

## Power tool use and care

1. **Do not force the power tool. Use the correct power tool for your application.** The correct power tool will do the job better and safer at the rate for which it was designed.
2. **Do not use the power tool if the switch does not turn it on and off.** Any power tool that cannot be controlled with the switch is dangerous and must be repaired.
3. **Disconnect the plug from the power source and/or remove the battery pack, if detachable, from the power tool before making any adjustments, changing accessories, or storing power tools.** Such preventive safety measures reduce the risk of starting the power tool accidentally.
4. **Store idle power tools out of the reach of children and do not allow persons unfamiliar with the power tool or these instructions to operate the power tool.** Power tools are dangerous in the hands of untrained users.
5. **Maintain power tools and accessories. Check for misalignment or binding of moving parts, breakage of parts and any other condition that may affect the power tool's operation. If damaged, have the power tool repaired before use.** Many accidents are caused by poorly maintained power tools.
6. **Keep cutting tools sharp and clean.** Properly maintained cutting tools with sharp cutting edges are less likely to bind and are easier to control.
7. **Use the power tool, accessories and tool bits etc. in accordance with these instructions, taking into account the working conditions and the work to be performed.** Use of the power tool for operations different from those intended could result in a hazardous situation.
8. **Keep handles and grasping surfaces dry, clean and free from oil and grease.** Slippery handles and grasping surfaces do not allow for safe handling and control of the tool in unexpected situations.
9. **When using the tool, do not wear cloth work gloves which may be entangled.** The entanglement of cloth work gloves in the moving parts may result in personal injury.

## Battery tool use and care

1. **Recharge only with the charger specified by the manufacturer.** A charger that is suitable for one type of battery pack may create a risk of fire when used with another battery pack.
2. **Use power tools only with specifically designated battery packs.** Use of any other battery packs may create a risk of injury and fire.
3. **When battery pack is not in use, keep it away from other metal objects, like paper clips, coins, keys, nails, screws or other small metal objects, that can make a connection from one terminal to another.** Shorting the battery terminals together may cause burns or a fire.
4. **Under abusive conditions, liquid may be ejected from the battery; avoid contact. If contact accidentally occurs, flush with water. If liquid contacts eyes, additionally seek medical help.** Liquid ejected from the battery may cause irritation or burns.

5. **Do not use a battery pack or tool that is damaged or modified.** Damaged or modified batteries may exhibit unpredictable behaviour resulting in fire, explosion or risk of injury.
6. **Do not expose a battery pack or tool to fire or excessive temperature.** Exposure to fire or temperature above 130 °C may cause explosion.
7. **Follow all charging instructions and do not charge the battery pack or tool outside the temperature range specified in the instructions.** Charging improperly or at temperatures outside the specified range may damage the battery and increase the risk of fire.

#### Service

1. **Have your power tool serviced by a qualified repair person using only identical replacement parts.** This will ensure that the safety of the power tool is maintained.
2. **Never service damaged battery packs.** Service of battery packs should only be performed by the manufacturer or authorized service providers.
3. **Follow instruction for lubricating and changing accessories.**

### Cordless impact driver safety warnings

1. **Hold the power tool by insulated gripping surfaces, when performing an operation where the fastener may contact hidden wiring.** Fasteners contacting a "live" wire may make exposed metal parts of the power tool "live" and could give the operator an electric shock.
2. **Always be sure you have a firm footing. Be sure no one is below when using the tool in high locations.**
3. **Hold the tool firmly.**
4. **Wear ear protectors.**
5. **Do not touch the bit or the workpiece immediately after operation. They may be extremely hot and could burn your skin.**
6. **Keep hands away from rotating parts.**
7. **Use auxiliary handle(s), if supplied with the tool.** Loss of control can cause personal injury.
8. **Hold the power tool by insulated gripping surfaces, when performing an operation where the cutting accessory may contact hidden wiring.** Cutting accessory contacting a "live" wire may make exposed metal parts of the power tool "live" and could give the operator an electric shock.
9. **Make sure there are no electrical cables, water pipes, gas pipes etc. that could cause a hazard if damaged by use of the tool.**

### SAVE THESE INSTRUCTIONS.

**⚠WARNING:** DO NOT let comfort or familiarity with product (gained from repeated use) replace strict adherence to safety rules for the subject product.

**MISUSE** or failure to follow the safety rules stated in this instruction manual may cause serious personal injury.

### Important safety instructions for battery cartridge

1. **Before using battery cartridge, read all instructions and cautionary markings on (1) battery charger, (2) battery, and (3) product using battery.**
  2. **Do not disassemble or tamper with the battery cartridge.** It may result in a fire, excessive heat, or explosion.
  3. **If operating time has become excessively shorter, stop operating immediately.** It may result in a risk of overheating, possible burns and even an explosion.
  4. **If electrolyte gets into your eyes, rinse them out with clear water and seek medical attention right away.** It may result in loss of your eyesight.
  5. **Do not short the battery cartridge:**
    - (1) **Do not touch the terminals with any conductive material.**
    - (2) **Avoid storing battery cartridge in a container with other metal objects such as nails, coins, etc.**
    - (3) **Do not expose battery cartridge to water or rain.**
- A battery short can cause a large current flow, overheating, possible burns and even a breakdown.**
6. **Do not store and use the tool and battery cartridge in locations where the temperature may reach or exceed 50 °C (122 °F).**
  7. **Do not incinerate the battery cartridge even if it is severely damaged or is completely worn out.** The battery cartridge can explode in a fire.
  8. **Do not nail, cut, crush, throw, drop the battery cartridge, or hit against a hard object to the battery cartridge.** Such conduct may result in a fire, excessive heat, or explosion.
  9. **Do not use a damaged battery.**
  10. **The contained lithium-ion batteries are subject to the Dangerous Goods Legislation requirements.**

For commercial transports e.g. by third parties, forwarding agents, special requirement on packaging and labeling must be observed.

For preparation of the item being shipped, consulting an expert for hazardous material is required. Please also observe possibly more detailed national regulations.

Tape or mask off open contacts and pack up the battery in such a manner that it cannot move around in the packaging.
  11. **When disposing the battery cartridge, remove it from the tool and dispose of it in a safe place.** Follow your local regulations relating to disposal of battery.
  12. **Use the batteries only with the products specified by Makita.** Installing the batteries to non-compliant products may result in a fire, excessive heat, explosion, or leak of electrolyte.

13. If the tool is not used for a long period of time, the battery must be removed from the tool.
14. During and after use, the battery cartridge may take on heat which can cause burns or low temperature burns. Pay attention to the handling of hot battery cartridges.
15. Do not touch the terminal of the tool immediately after use as it may get hot enough to cause burns.
16. Do not allow chips, dust, or soil stuck into the terminals, holes, and grooves of the battery cartridge. It may cause heating, catching fire, burst and malfunction of the tool or battery cartridge, resulting in burns or personal injury.
17. Unless the tool supports the use near high-voltage electrical power lines, do not use the battery cartridge near high-voltage electrical power lines. It may result in a malfunction or breakdown of the tool or battery cartridge.
18. Keep the battery away from children.

## SAVE THESE INSTRUCTIONS.

**CAUTION:** Only use genuine Makita batteries. Use of non-genuine Makita batteries, or batteries that have been altered, may result in the battery bursting causing fires, personal injury and damage. It will also void the Makita warranty for the Makita tool and charger.

## Tips for maintaining maximum battery life

1. Charge the battery cartridge before completely discharged. Always stop tool operation and charge the battery cartridge when you notice less tool power.
2. Never recharge a fully charged battery cartridge. Overcharging shortens the battery service life.
3. Charge the battery cartridge with room temperature at 10 °C - 40 °C (50 °F - 104 °F). Let a hot battery cartridge cool down before charging it.
4. When not using the battery cartridge, remove it from the tool or the charger.
5. Charge the battery cartridge if you do not use it for a long period (more than six months).

## FUNCTIONAL DESCRIPTION

**CAUTION:** Always be sure that the tool is switched off and the battery cartridge is removed before adjusting or checking function on the tool.

### Installing or removing battery cartridge

**CAUTION:** Always switch off the tool before installing or removing of the battery cartridge.

**CAUTION:** Hold the tool and the battery cartridge firmly when installing or removing battery cartridge. Failure to hold the tool and the battery cartridge firmly may cause them to slip off your hands and result in damage to the tool and battery cartridge and a personal injury.

To install the battery cartridge, align the tongue on the battery cartridge with the groove in the housing and slip it into place. Insert it all the way until it locks in place with a little click. If you can see the red indicator as shown in the figure, it is not locked completely.

To remove the battery cartridge, slide it from the tool while sliding the button on the front of the cartridge.

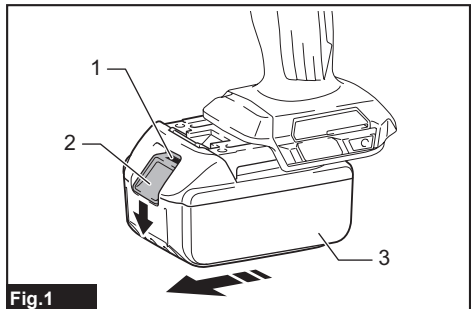

Fig.1

▶ 1. Red indicator 2. Button 3. Battery cartridge

**CAUTION:** Always install the battery cartridge fully until the red indicator cannot be seen. If not, it may accidentally fall out of the tool, causing injury to you or someone around you.

**CAUTION:** Do not install the battery cartridge forcibly. If the cartridge does not slide in easily, it is not being inserted correctly.

## Tool / battery protection system

The tool is equipped with a tool/battery protection system. This system automatically cuts off power to the motor to extend tool and battery life. The tool will automatically stop during operation if the tool or battery is placed under one of the following conditions:

### Overload protection

When the battery is operated in a manner that causes it to draw an abnormally high current, the tool automatically stops without any indication. In this situation, turn the tool off and stop the application that caused the tool to become overloaded. Then turn the tool on to restart.

### Overheat protection

When the tool or battery is overheated, the tool stops automatically. In this case, let the tool and battery cool before turning the tool on again.

**NOTE:** When the tool is overheated, the lamp blinks.

### Overdischarge protection

When the battery capacity is not enough, the tool stops automatically. In this case, remove the battery from the tool and charge the battery.

### Protections against other causes

Protection system is also designed for other causes that could damage the tool and allows the tool to stop automatically. Take all the following steps to clear the causes, when the tool has been brought to a temporary halt or stop in operation.

1. Turn the tool off, and then turn it on again to restart.
2. Charge the battery(ies) or replace it/them with recharged battery(ies).
3. Let the tool and battery(ies) cool down.

If no improvement can be found by restoring protection system, then contact your local Makita Service Center.

## Indicating the remaining battery capacity

### Only for battery cartridges with the indicator

Press the check button on the battery cartridge to indicate the remaining battery capacity. The indicator lamps light up for a few seconds.

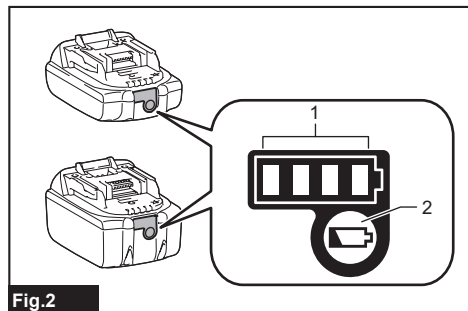

Fig.2

- 1. Indicator lamps 2. Check button

Indicator lamps			Remaining capacity
Lighted	Off	Blinking	
■ ■ ■ ■			75% to 100%
■ ■ ■ □			50% to 75%
■ ■ □ □			25% to 50%
■ □ □ □			0% to 25%
▬ □ □ □			Charge the battery.
■ ■ □ □			The battery may have malfunctioned.
□ □ ■ ■	↑ ↓		

**NOTE:** Depending on the conditions of use and the ambient temperature, the indication may differ slightly from the actual capacity.

**NOTE:** The first (far left) indicator lamp will blink when the battery protection system works.

## Switch action

**CAUTION:** Before installing the battery cartridge into the tool, always check to see that the switch trigger actuates properly and returns to the "OFF" position when released.

To start the tool, simply pull the switch trigger. Tool speed is increased by increasing pressure on the switch trigger. Release the switch trigger to stop.

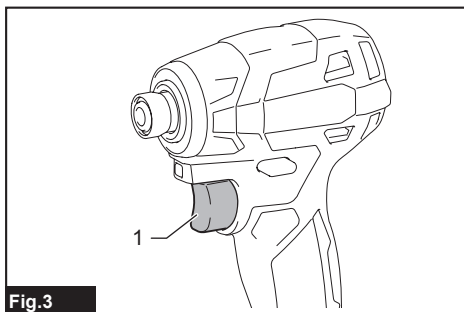

Fig.3

- 1. Switch trigger

**NOTE:** The tool automatically stops if you keep pulling the switch trigger for about 6 minutes.

**NOTE:** While pulling the switch trigger, any other buttons do not work.

## Reversing switch action

**CAUTION:** Always check the direction of rotation before operation.

**CAUTION:** Use the reversing switch only after the tool comes to a complete stop. Changing the direction of rotation before the tool stops may damage the tool.

**CAUTION:** When not operating the tool, always set the reversing switch lever to the neutral position.

This tool has a reversing switch to change the direction of rotation. Depress the reversing switch lever from the A side for clockwise rotation or from the B side for counterclockwise rotation.

When the reversing switch lever is in the neutral position, you cannot start the tool.

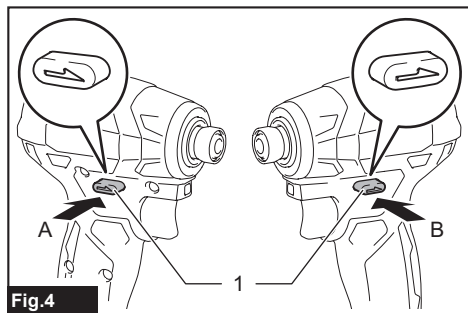

Fig.4

► 1. Reversing switch lever

## Electric brake

This tool is equipped with an electric brake. If the tool consistently fails to quickly stop after the switch trigger is released, have the tool serviced at a Makita service center.

## Lighting up the front lamp

**CAUTION:** Do not look in the light or see the source of light directly.

Pull the switch trigger to turn on the front lamp. To turn off, release the switch trigger. The front lamp goes out approximately 10 seconds after releasing the switch trigger.

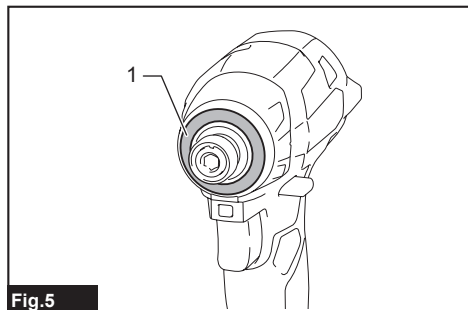

Fig.5

► 1. Front lamp

## Changing brightness

To change the brightness, press and hold the button . The brightness has three levels. Every time you press and hold the button , the brightness decreases and finally goes out. When the lamp status is off, the front lamp will not turn on even if the trigger is pulled. To turn on the lamp status again, press and hold the button . The brightness will return to the highest.

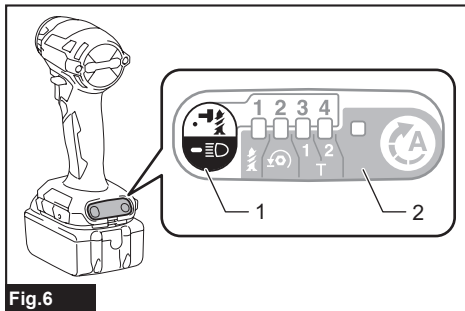

Fig.6

► 1. Button 2. Switch panel

**NOTE:** You can hold the button continuously to cycle the brightness between the three levels and the light off state.

**NOTE:** When the tool is overheated, the front lamp flash for one minute, and then the switch panel goes off. In this case, cool down the tool before operating again.

**NOTE:** To confirm the lamp status, pull the trigger when the reversing switch lever is not in the neutral position. When the front lamp lights up by pulling the switch trigger, the lamp status is on. When the front lamp does not light up, the lamp status is off.

**NOTE:** Use a dry cloth to wipe the dirt off the lens of the front lamp. Be careful not to scratch the lens of front lamp, or it may lower the illumination.

## Light mode

You can use the tool as a handy light.

To turn on the light, set the reversing switch lever in the neutral position and pull the switch trigger.

The lamp keeps lighting up for approximately one hour.

To turn off the light, pull the switch trigger again or depress the reversing switch lever.

## Changing brightness

To change the brightness, press the button . The brightness has three levels. Every time you press the button , the brightness decreases. The brightness will return to the highest when operating in the lowest brightness.

**NOTE:** You can hold the button continuously to cycle the brightness between the three levels.

**NOTE:** You cannot change the application mode while the light mode is on. The lamp on the switch panel does not turn on when the light mode is on.

**NOTE:** You cannot turn on/off the lamp status or change the application mode when the light mode is on.

**NOTE:** The light mode does not work when the tool/battery protection system activates or the battery capacity is not enough.



## Changing the application mode

### What's the application mode?

The application mode is the variation of the driving rotation and impact which are already preset in the tool. By choosing a suitable application mode depending on the work, you can accomplish quicker work and/or more beautiful finish.



This tool features following application modes:

#### Impact force

- 4 (Max)
- 3 (Hard)
- 2 (Medium)
- 1 (Soft)

#### Assist type

- Wood mode
- Bolt mode
- T mode (1)
- T mode (2)

The application mode can be changed by the button , , or the quick mode-switching button.

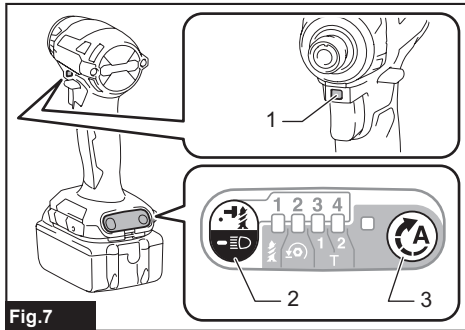





Fig.7

- ▶ 1. Quick mode-switching button
- ▶ 2. Button 
- ▶ 3. Button 

By registering a certain application mode to the tool, you can switch to the registered application mode by just pressing the quick mode-switching button (quick mode-switching function).

**NOTE:** When none of the lamp on the panel is lit, pull the switch trigger once before pressing the quick mode-switching button.

**NOTE:** You will not be able to change the application mode if you do not operate the tool for approximately one minute. In this case, pull the switch trigger once and press the button , , or quick mode-switching button.

**NOTE:** Refer to "Registering the application mode" in "Quick mode-switching function" section for how to register the application mode.

## Quick mode-switching button

The function of the quick mode-switching button varies depending on whether you have registered the application mode to the tool.

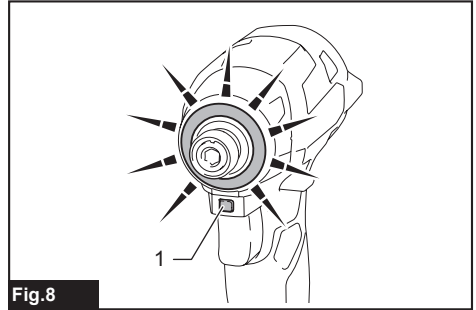

Fig.8

- ▶ 1. Quick mode-switching button

### When the application mode is not registered:

The level of impact force changes every time you press the quick mode-switching button. The front lamp will flash once when the impact force is changed by pressing the quick mode-switching button.

### When the application mode is registered:

The tool switches between the registered application mode and current application mode every time you press the quick mode-switching button. The front lamp will flash once when the application mode is changed by pressing the quick mode-switching button.

**NOTE:** When the lamp status is off, the front lamp will not flash even when the application mode is changed by pressing the quick mode-switching button.

**NOTE:** Refer to "Registering the application mode" in "Quick mode-switching function" section for how to register the application mode.

### Disabling the quick mode-switching button

You can also disable the quick mode-switching button. After disabling, the quick mode-switching button will not work for changing the impact force and switching the application mode.

To disable the quick mode-switching button, press and hold the quick mode-switching button and the button  at the same time until the all lamps on the panel blink.









To resume the quick mode-switching button, perform the same procedure as above again.

**NOTE:** Registering and erasing the application mode can be performed even if the quick mode-switching button is disabled. After registering or erasing the application mode, the quick mode-switching button will be activated.

## Quick reference

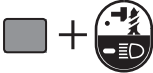
The following table shows the functions of the quick mode-switching button.

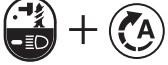
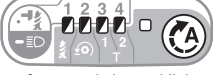
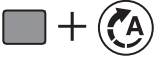
 indicates the quick mode-switching button.

Button(s) / Purpose	Action	How to confirm
 (When quick mode-switching function is OFF) Changing the impact force by the quick mode-switching button	Press	 The front lamp on the tool flash once.*
 (When quick mode-switching function is ON) Switching to the registered application mode	Press	 The front lamp on the tool flash once.*
 Registering the application mode	Press and hold (each button)	<b>Example: Wood mode is registered</b>  The lamp of desired application mode blinks.
 Erasing the registered application mode	Press and hold (each button)	 All impact force grade lamps blink.
 Disabling/resuming the quick mode-switching button	Press and hold (each button)	 All lamps on the panel blink.

: The lamp is blinking.

\* The front lamp will not flash when the lamp status is off.



## Changing the impact force

You can change the impact force in four steps: 4 (max), 3 (hard), 2 (medium), and 1 (soft).

This allows a tightening suitable to the work.

The level of impact force changes every time you press the button  or the quick mode-switching button.

You can change the impact force within approximately one minute after releasing the switch trigger.

**NOTE:** You can extend the time to change the impact force approximately one minute if you press the button , , or the quick mode-switching button.

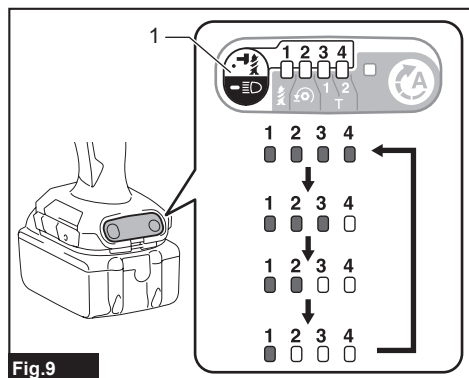
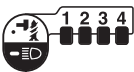
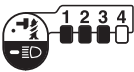
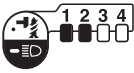



Fig.9

► 1. Button 

Application mode (Impact force grade displayed on panel)	Maximum blows	Purpose	Example of application
4 (Max) 	3,800 min <sup>-1</sup> (/min)	Tightening with the maximum force and speed.	Driving screws to underwork materials, tightening long screws or bolts.
3 (Hard) 	3,600 min <sup>-1</sup> (/min)	Tightening with less force and speed than Max mode (easier to control than Max mode).	Driving screws to underwork materials, tightening bolts.
2 (Medium) 	2,600 min <sup>-1</sup> (/min)	Tightening when a good finishing is needed.	Driving screws to finishing boards or plaster boards.
1 (Soft) 	1,100 min <sup>-1</sup> (/min)	Tightening with less force to avoid screw thread breakage.	Tightening sash screws or small screws such as M6.

: The lamp is on.

**NOTE:** When none of the lamp on the panel is lit, pull the switch trigger once before pressing the button  or the quick mode-switching button.



**NOTE:** All lamps on the switch panel go out when the tool is turned off to save the battery power. The impact force grade can be checked by pulling the switch trigger to the extent that the tool does not operate.

## Changing assist type

This tool employs assist function that offers several easy-to-use application modes for driving screws with good control.

The type of the application mode changes every time you press the button .

You can change the assist type within approximately one minute after releasing the switch trigger.

**NOTE:** You can extend the time to change the assist type approximately one minute if you press the button , , or the quick mode-switching button.

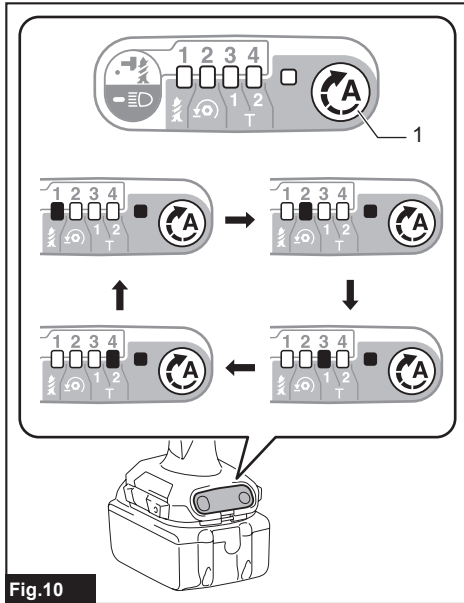







Fig.10

► 1. Button 

Application mode (Assist type displayed on panel)	Maximum blows	Feature	Purpose
Wood mode * 	3,800 min <sup>-1</sup> (/min)	This mode helps to prevent a screw from falling at the beginning of driving. The tool drives a screw with low-speed rotation at first. After the tool starts to impact, the rotation speed increases and reaches the maximum speed.	Tightening long screws.
Bolt mode 	3,800 min <sup>-1</sup> (/min)	This mode helps to prevent a bolt from falling off. When loosening a bolt with the tool driving in counterclockwise rotation, the tool automatically stops after the bolt/nut gets enough loosened. The stroke of the switch trigger to reach maximum speed will become short in this mode.	Loosening bolts.
T mode (1) * 	— (The tool stops rotating soon after impact starts.)	This mode helps to prevent the screws from over-tightening. It also accomplishes quick operation and good finish at the same time. The tool drives a screw with high-speed rotation and stops soon after the tool starts to impact. <b>NOTE:</b> The timing to stop the driving varies depending on the type of the screw and material to be driven. Make a test driving before using this mode.	Driving self-drilling screws to a thin metal plate with good finish.
T mode (2) * 	2,600 min <sup>-1</sup> (/min)	This mode helps to prevent the screws from breakage and stripping. It also accomplishes quick operation and good finish at the same time. The tool drives a screw with high-speed rotation and slows down the rotation when the tool starts to impact. <b>NOTE:</b> Release the switch trigger as soon as the tightening finished to avoid overtightening.	Driving self-drilling screws to a thick metal plate with good finish.

: The lamp is on.

\* When the tool rotates counterclockwise, it rotates the same as the 4 (max) mode, 3,800 min<sup>-1</sup> (/min).

**NOTE:** When none of the lamp on the panel is lit, pull the switch trigger once before pressing the button .

**NOTE:** All lamps on the switch panel go out when the tool is turned off to save the battery power. The type of the application mode can be checked by pulling the switch trigger to the extent that the tool does not operate.

## Quick mode-switching function

### What you can do with the quick mode-switching function

The quick mode-switching function saves the time for changing the application mode of the tool. You can switch to your desired application mode by just pressing the quick mode-switching button. It is helpful when doing a repetitive work which requires to switch between two application modes alternately.

**EXAMPLE** If you have a work to use T mode and max impact force, register the max impact force for quick mode-switching function. Once register it, you can switch to the max impact force from T mode by just one click of the quick mode-switching button. Also, you can return to T mode by pressing the quick mode-switching button again.

Even if the tool is in other application mode than T mode, pressing the quick mode-switching button changes to max impact force. It is convenient for you to register an application mode that you frequently use.

You can choose one of following application modes for quick mode-switching function:

#### Impact force



- 4 (Max)
- 3 (Hard)
- 2 (Medium)
- 1 (Soft)

#### Assist type

- Wood mode
- Bolt mode
- T mode (1)
- T mode (2)

### Registering application mode

To use the quick mode-switching function, register your desired application mode to the tool beforehand.

1. With the button  or , choose your desired application mode.
2. Press and hold the button  and the quick mode-switching button at the same time until the lamp of desired application mode blinks.

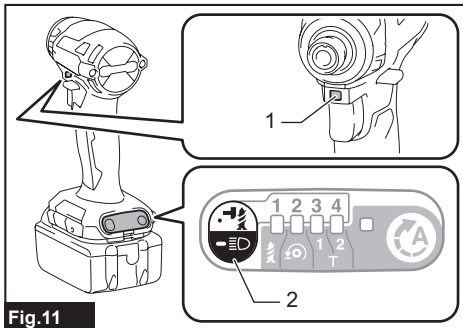

Fig.11

- 1. Quick mode-switching button 2. Button 

**NOTE:** You can overwrite the current application mode with new one by performing the procedure above.

## Using the quick mode-switching function

When the tool is in the mode that is not registered, press the quick mode-switching button to switch to the registered application mode. The tool switches between the registered application mode and last application mode every time you press the quick mode-switching button. The front lamp will flash once when switching to the registered application mode.











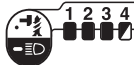



The lamp of the registered application mode will blink when using the registered application mode.

## Erasing the registered application mode

Press and hold the button  and  button at the same time until all impact force grade lamps blink.

**NOTE:** After erasing the registered application mode, the quick mode-switching button works for changing the impact force.

## Indication patterns

Application mode	While registering the application mode	When the registered application mode turns on
4 (Max)		
3 (Hard)		
2 (Medium)		
1 (Soft)		
Wood mode		
Bolt mode		
T mode (1)		
T mode (2)		

: The lamp is on.

: The lamp is blinking.

# ASSEMBLY

**⚠ CAUTION:** Always be sure that the tool is switched off and the battery cartridge is removed before carrying out any work on the tool.

## Installing or removing driver bit/socket bit

Use only driver bit/socket bit that has inserting portion shown in the figure. Do not use any other driver bit/socket bit.

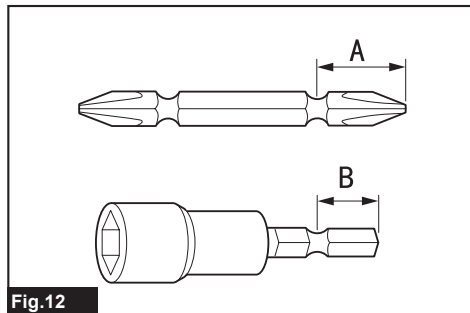

Fig.12

### For tool with shallow driver bit hole

A=12mm B=9mm	Use only these types of driver bits. Follow the procedure 1. (Note) Bit-piece is not necessary.
-----------------	--

### For tool with deep driver bit hole

A=17mm B=14mm	To install these types of driver bits, follow the procedure 1.
A=12mm B=9mm	To install these types of driver bits, follow the procedure 2. (Note) Bit-piece is necessary for installing the bit.

## Procedure 1

### For tool without one-touch type sleeve

To install the driver bit, pull the sleeve in the direction of the arrow and insert the driver bit into the sleeve as far as it will go. Then release the sleeve to secure the driver bit.

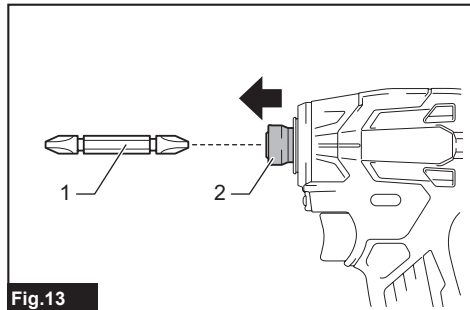

Fig.13

► 1. Driver bit 2. Sleeve

### For tool with one-touch type sleeve

To install the driver bit, insert the driver bit into the sleeve as far as it will go.

## Procedure 2

In addition to Procedure 1, insert the bit-piece into the sleeve with its pointed end facing in.

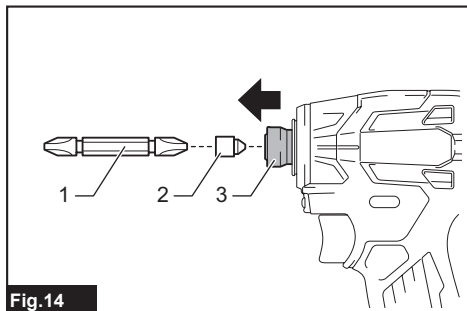

Fig.14

► 1. Driver bit 2. Bit-piece 3. Sleeve

To remove the driver bit, pull the sleeve in the direction of the arrow and pull the driver bit out.

**NOTE:** If the driver bit is not inserted deep enough into the sleeve, the sleeve will not return to its original position and the driver bit will not be secured. In this case, try re-inserting the bit according to the instructions above.

**NOTE:** When it is difficult to insert the driver bit, pull the sleeve and insert it into the sleeve as far as it will go.

**NOTE:** After inserting the driver bit, make sure that it is firmly secured. If it comes out, do not use it.

## Installing hook

**⚠ WARNING:** Use the hanging/mounting parts for their intended purposes only, e.g., hanging the tool on a tool belt between jobs or work intervals.

**⚠ WARNING:** Be careful not to overload the hook as too much force or irregular overburden may cause damages to the tool resulting in personal injury.

**⚠ CAUTION:** When installing the hook, always secure it with the screw firmly. If not, the hook may come off from the tool and result in the personal injury.

**⚠ CAUTION:** Make sure to hang the tool securely before releasing your hold. Insufficient or unbalanced hooking may cause falling off and you may be injured.

The hook is convenient for temporarily hanging the tool. This can be installed on either side of the tool. To install the hook, insert it into a groove in the tool housing on either side and then secure it with a screw. To remove, loosen the screw and then take it out.

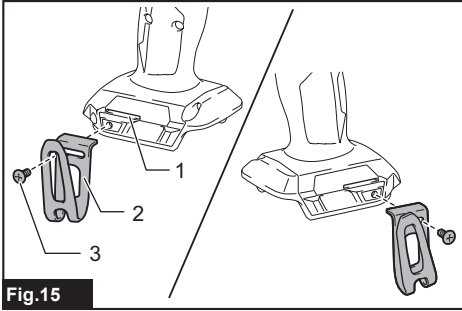

Fig.15

► 1. Groove 2. Hook 3. Screw

## OPERATION

The proper fastening torque may differ depending upon the kind or size of the screw/bolt, the material of the workpiece to be fastened, etc. The relation between fastening torque and fastening time is shown in the figures.

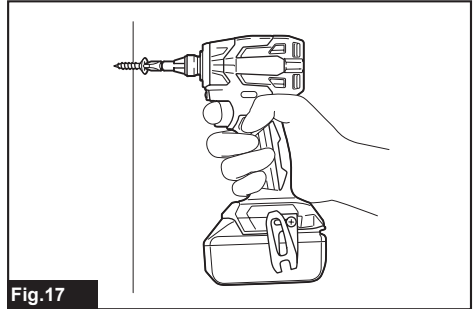

Fig.17

## Using hole

**⚠ WARNING:** Never use the hanging hole for unintended purpose, for instance, tethering the tool at high location. Bearing stress in a heavily loaded hole may cause damages to the hole, resulting in injuries to you or people around or below you.

Use the hanging hole at the bottom rear of the tool to hang the tool on a wall using a hanging cord or similar strings.

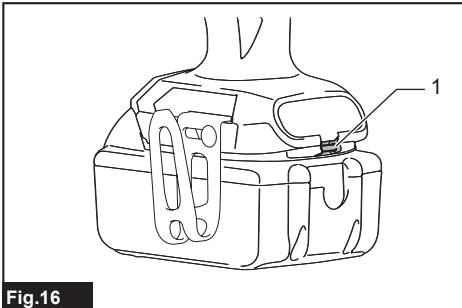
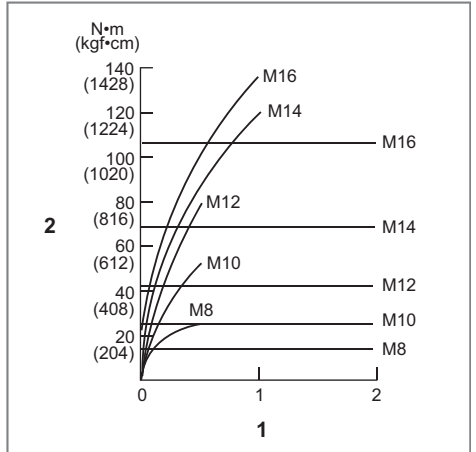

Fig.16

► 1. Hanging hole

The relation between fastening torque and fastening time for standard bolt (when impact force is 4)



1. Fastening time (second) 2. Fastening torque



**The relation between fastening torque and fastening time for high tensile bolt (when impact force is 4)**

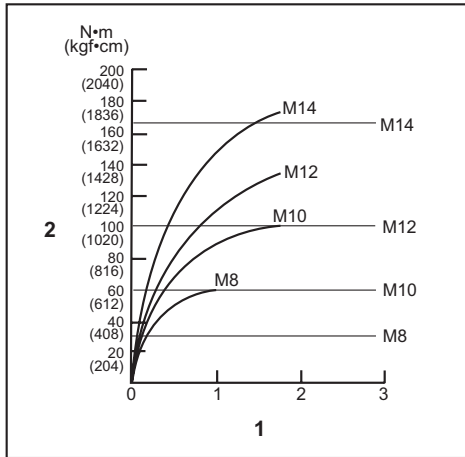

1. Fastening time (second) 2. Fastening torque

Hold the tool firmly and place the point of the driver bit in the screw head. Apply forward pressure to the tool to the extent that the bit will not slip off the screw and turn the tool on to start operation.

**NOTICE:** If you use a spare battery to continue the operation, rest the tool at least 15 min.

**NOTE:** Use the proper bit for the head of the screw/bolt that you wish to use.

**NOTE:** When fastening M8 or smaller screw, choose a proper impact force and carefully adjust pressure on the switch trigger so that the screw is not damaged.

**NOTE:** Hold the tool pointed straight at the screw.

**NOTE:** If the impact force is too strong or you tighten the screw for a time longer than shown in the figures, the screw or the point of the driver bit may be overstressed, stripped, damaged, etc. Before starting your job, always perform a test operation to determine the proper fastening time for your screw.

The fastening torque is affected by a wide variety of factors including the following. After fastening, always check the torque with a torque wrench.

1. When the battery cartridge is discharged almost completely, voltage will drop and the fastening torque will be reduced.
2. Driver bit or socket bit  
Failure to use the correct size driver bit or socket bit will cause a reduction in the fastening torque.
3. Bolt
  - Even though the torque coefficient and the class of bolt are the same, the proper fastening torque will differ according to the diameter of bolt.
  - Even though the diameters of bolts are the same, the proper fastening torque will differ according to the torque coefficient, the class of bolt and the bolt length.

4. The manner of holding the tool or the material of driving position to be fastened will affect the torque.
5. Operating the tool at low speed will cause a reduction in the fastening torque.

## MAINTENANCE

**CAUTION:** Always be sure that the tool is switched off and the battery cartridge is removed before attempting to perform inspection or maintenance.

**NOTICE:** Never use gasoline, benzine, thinner, alcohol or the like. Discoloration, deformation or cracks may result.

To maintain product SAFETY and RELIABILITY, repairs, any other maintenance or adjustment should be performed by Makita Authorized or Factory Service Centers, always using Makita replacement parts.

## OPTIONAL ACCESSORIES

**CAUTION:** These accessories or attachments are recommended for use with your Makita tool specified in this manual. The use of any other accessories or attachments might present a risk of injury to persons. Only use accessory or attachment for its stated purpose.

If you need any assistance for more details regarding these accessories, ask your local Makita Service Center.

- Driver bits
- Socket bits
- Bit piece
- Hook
- Tool hanger
- Plastic carrying case
- Makita genuine battery and charger
- Battery protector

**NOTE:** Some items in the list may be included in the tool package as standard accessories. They may differ from country to country.





# Makita Europe N.V.

Jan-Baptist Vinkstraat 2, 3070 Kortenberg, Belgium

# Makita Corporation

3-11-8, Sumiyoshi-cho, Anjo, Aichi 446-8502 Japan

[www.makita.com](http://www.makita.com)



885A16A226 EN 20221026
------------------------------