

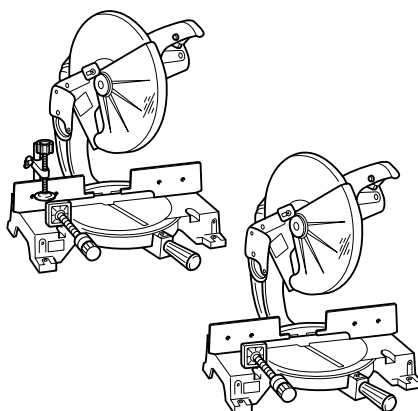

INSTRUCTION MANUAL

# Miter Saw

LS1440



012687

 DOUBLE INSULATION

**IMPORTANT:** Read Before Using.

## ENGLISH (Original instructions)

# SPECIFICATIONS

Blade diameter	355 mm
Blade body thickness	2.0 mm - 2.6 mm
Hole diameter	25 mm and 25.4 mm
Max. Miter angle	Left 45°, Right 45°
Max. Cutting capacities (H x W)	

Miter angle	
0°	45° (left and right)
122 mm x 152 mm	122 mm x 115 mm

No load speed (min <sup>-1</sup> )	3,200
Dimensions (L x W x H)	596 mm x 550 mm x 630 mm
Net weight	34.2 kg
Safety class	▣/II

- Due to our continuing programme of research and development, the specifications herein are subject to change without notice.
- Specifications may differ from country to country.
- Weight according to EPTA-Procedure 01/2003

END201-5

ENF100-1

## Symbols

The following show the symbols used for the equipment. Be sure that you understand their meaning before use.



- Read instruction manual.



- DOUBLE INSULATION



- Only for EU countries  
Do not dispose of electric equipment together with household waste material! In observance of European Directive 2002/96/EC on waste electric and electronic equipment and its implementation in accordance with national law, electric equipment that have reached the end of their life must be collected separately and returned to an environmentally compatible recycling facility.

ENE004-1

## Intended use

The tool is intended for accurate straight and miter cutting in wood. With appropriate saw blades, aluminum can also be sawed.

ENF002-2

## Power supply

The tool should be connected only to a power supply of the same voltage as indicated on the nameplate, and can only be operated on single-phase AC supply. They are double-insulated and can, therefore, also be used from sockets without earth wire.

## For public low-voltage distribution systems of between 220 V and 250 V.

Switching operations of electric apparatus cause voltage fluctuations. The operation of this device under unfavorable mains conditions can have adverse effects to the operation of other equipment. With a mains impedance equal or less than 0.40 Ohms it can be presumed that there will be no negative effects. The mains socket used for this device must be protected with a fuse or protective circuit breaker having slow tripping characteristics.

ENG905-1

## Noise

The typical A-weighted noise level determined according to EN61029:

- Sound pressure level ( $L_{pA}$ ) : 94 dB(A)
- Sound power level ( $L_{WA}$ ) : 105 dB(A)
- Uncertainty (K) : 3 dB(A)

## Wear ear protection

ENG900-1

## Vibration

The vibration total value (tri-axial vector sum) determined according to EN61029:

- Vibration emission ( $a_{h1}$ ) : 2.5 m/s<sup>2</sup>
- Uncertainty (K) : 1.5 m/s<sup>2</sup>

ENG901-1

- The declared vibration emission value has been measured in accordance with the standard test method and may be used for comparing one tool with another.

- The declared vibration emission value may also be used in a preliminary assessment of exposure.

**⚠WARNING:**

- The vibration emission during actual use of the power tool can differ from the declared emission value depending on the ways in which the tool is used.
- Be sure to identify safety measures to protect the operator that are based on an estimation of exposure in the actual conditions of use (taking account of all parts of the operating cycle such as the times when the tool is switched off and when it is running idle in addition to the trigger time).

ENH003-13

**For European countries only**

**EC Declaration of Conformity**

**We Makita Corporation as the responsible manufacturer declare that the following Makita machine(s):**

Designation of Machine:

Miter Saw

Model No./ Type: LS1440

are of series production and

**Conforms to the following European Directives:**

2006/42/EC

And are manufactured in accordance with the following standards or standardised documents:

EN61029

The technical documentation is kept by our authorised representative in Europe who is:

Makita International Europe Ltd.

Michigan Drive, Tongwell,

Milton Keynes, Bucks MK15 8JD, England

30.1.2009



Tomoyasu Kato

Director

Makita Corporation

3-11-8, Sumiyoshi-cho,

Anjo, Aichi, 446-8502, JAPAN

000230

ENA001-2

**SAFETY INSTRUCTIONS**

**WARNING! When using electric tools, basic safety precautions, including the following, should always be followed to reduce the risk of fire, electric shock and personal injury. Read all these instructions before operating this product and save these instructions.**

**For safe operations:**

1. **Keep work area clean.**  
Cluttered areas and benches invite injuries.
2. **Consider work area environment.**  
Do not expose power tools to rain. Do not use power tools in damp or wet locations. Keep work area well lit. Do not use power tools where there is risk to cause fire or explosion.
3. **Guard against electric shock.**  
Avoid body contact with earthed or grounded surfaces (e.g. pipes, radiators, ranges, refrigerators).
4. **Keep children away.**  
Do not let visitors touch the tool or extension cord. All visitors should be kept away from work area.
5. **Store idle tools.**  
When not in use, tools should be stored in a dry, high or locked up place, out of reach of children.
6. **Do not force the tool.**  
It will do the job better and safer at the rate for which it was intended.
7. **Use the right tool.**  
Do not force small tools or attachments to do the job of a heavy duty tool. Do not use tools for purposes not intended; for example, do not use circular saws to cut tree limbs or logs.
8. **Dress properly.**  
Do not wear loose clothing or jewellery, they can be caught in moving parts. Rubber gloves and non-skid footwear are recommended when working outdoors. Wear protecting hair covering to contain long hair.
9. **Use safety glasses and hearing protection.**  
Also use face or dust mask if the cutting operation is dusty.
10. **Connect dust extraction equipment.**  
If devices are provided for the connection of dust extraction and collection facilities ensure these are connected and properly used.
11. **Do not abuse the cord.**  
Never carry the tool by the cord or yank it to disconnect it from the socket. Keep the cord away from heat, oil and sharp edges.
12. **Secure work.**  
Use clamps or a vice to hold the work. It is safer than using your hand and it frees both hands to operate the tool.
13. **Do not overreach.**  
Keep proper footing and balance at all times.
14. **Maintain tools with care.**  
Keep cutting tools sharp and clean for better and safer performance. Follow instructions for lubrication and changing accessories. Inspect tool cord periodically and if damaged have it repaired

by an authorized service facility. Inspect extension cords periodically and replace, if damaged. Keep handles dry, clean and free from oil and grease.

15. **Disconnect tools.**

When not in use, before servicing and when changing accessories such as blades, bits and cutters.

16. **Remove adjusting keys and wrenches.**

Form the habit of checking to see that keys and adjusting wrenches are removed from the tool before turning it on.

17. **Avoid unintentional starting.**

Do not carry a plugged-in tool with a finger on the switch. Ensure switch is off when plugging in.

18. **Use outdoor extension leads.**

When tool is used outdoors, use only extension cords intended for outdoor use.

19. **Stay alert.**

Watch what you are doing. Use common sense. Do not operate tool when you are tired.

20. **Check damaged parts.**

Before further use of the tool, a guard or other part that is damaged should be carefully checked to determine that it will operate properly and perform its intended function. Check for alignment of moving parts, free running of moving parts, breakage of parts, mounting and any other conditions that may affect its operation. A guard or other part that is damaged should be properly repaired or replaced by an authorized service center unless otherwise indicated in this instruction manual. Have defective switches replaced by an authorized service facility. Do not use the tool if the switch does not turn it on and off.

21. **Warning.**

The use of any accessory or attachment, other than those recommended in this instruction manual or the catalog, may present a risk of personal injury.

22. **Have your tool repaired by a qualified person.**

This electric tool is in accordance with the relevant safety requirements. Repairs should only be carried out by qualified persons using original spare parts, otherwise this may result in considerable danger to the user.

ENB120-1

## ADDITIONAL SAFETY RULES FOR TOOL

1. **Wear eye protection.**
2. **Keep hands out of path of saw blade. Avoid contact with any coasting blade. It can still cause severe injury.**
3. **Do not operate saw without guards in place. Check blade guard for proper closing before each use. Do not operate saw if blade guard does not move freely and close instantly. Never clamp or tie the blade guard into the open position.**
4. **Do not perform any operation freehand.** The workpiece must be secured firmly against the turn base and guide fence with the vise during all operations. Never use your hand to secure the workpiece.
5. **Never reach around saw blade.**
6. **Turn off tool and wait for saw blade to stop before moving workpiece or changing settings.**
7. **Unplug tool before changing blade or servicing.**
8. **Always secure all moving portions before carrying the tool.**
9. **Stopper pin which locks the cutter head down is for carrying and storage purposes only and not for any cutting operations.**
10. **Do not use the tool in the presence of flammable liquids or gases.** The electrical operation of the tool could create an explosion and fire when exposed to flammable liquids or gases.
11. **Check the blade carefully for cracks or damage before operation. Replace cracked or damaged blade immediately.**
12. **Use only flanges specified for this tool.**
13. **Be careful not to damage the arbor, flanges (especially the installing surface) or bolt. Damage to these parts could result in blade breakage.**
14. **Make sure that the turn base is properly secured so it will not move during operation.**
15. **For your safety, remove the chips, small pieces, etc. from the table top before operation.**
16. **Avoid cutting nails. Inspect for and remove all nails from the workpiece before operation.**
17. **Make sure the shaft lock is released before the switch is turned on.**
18. **Be sure that the blade does not contact the turn base in the lowest position.**
19. **Hold the handle firmly. Be aware that the saw moves up or down slightly during start-up and stopping.**
20. **Make sure the blade is not contacting the workpiece before the switch is turned on.**
21. **Before using the tool on an actual workpiece, let it run for a while. Watch for vibration or wobbling that could indicate poor installation or a poorly balanced blade.**
22. **Wait until the blade attains full speed before cutting.**

23. Stop operation immediately if you notice anything abnormal.
24. Do not attempt to lock the trigger in the on position.
25. Be alert at all times, especially during repetitive, monotonous operations. Do not be lulled into a false sense of security. Blades are extremely unforgiving.
26. Always use accessories recommended in this manual. Use of improper accessories such as abrasive wheels may cause an injury.
27. Do not use the saw to cut other than wood, aluminum or similar materials.
28. Connect miter saws to a dust collecting device when sawing.
29. Select saw blades in relation to the material to be cut.
30. Take care when slotting.
31. Replace the kerf board when worn.
32. Do not use saw blades manufactured from high speed steel.
33. Some dust created from operation contains chemicals known to cause cancer, birth defects or other reproductive harm. Some examples of these chemicals are:
  - lead from lead-based-painted material and, arsenic and chromium from chemically-treated lumber.

Your risk from these exposures varies, depending on how often you do this type of work. To reduce your exposure to these chemicals: work in a well ventilated area and work with approved safety equipment, such as those dust masks that are specially designed to filter out microscopic particles.
34. To reduce the emitted noise, always be sure that the blade is sharp and clean.
35. The operator is adequately trained in the use, adjustment and operation of the machine.
36. Use correctly sharpened saw blades. Observe the maximum speed marked on the saw blade.
37. Refrain from removing any cut-offs or other parts of the workpiece from the cutting area whilst the tool is running and the saw head is not in the rest position.
38. Use only saw blades recommended by the manufacturer which conform to EN847-1.
39. Wear gloves for handling saw blade (saw blades shall be carried in a holder wherever practicable) and rough material.

**SAVE THESE INSTRUCTIONS.**

## INSTALLATION

### Bench mounting

When the tool is shipped, the handle is locked in the lowered position by the handle latch. Release the handle latch by lowering the handle slightly and turn the handle latch to the released position.

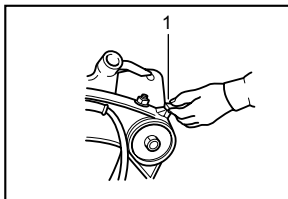

1. Handle latch

002147

This tool should be bolted with four bolts to a level and stable surface using the bolt holes provided in the tool's base. This will help prevent tipping and possible injury.

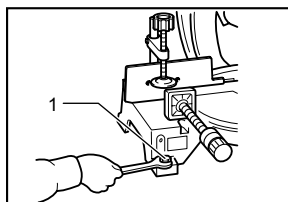

1. Bolt

012669

### Installing the holders (optional accessories)

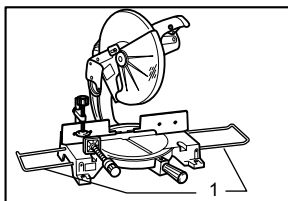

1. Holder

012673

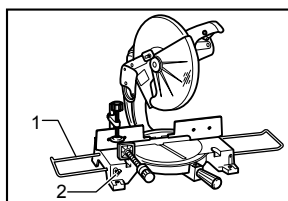

1. Holder  
2. Screw

012674

Install the holders on both sides of the base and secure them with screws.

## FUNCTIONAL DESCRIPTION

### ⚠ CAUTION:

- Always be sure that the tool is switched off and unplugged before adjusting or checking function on the tool.

### Blade guard

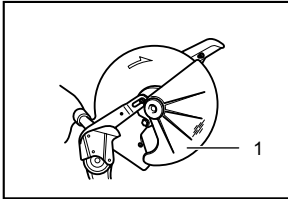

002149

1. Blade guard

When lowering the handle, the blade guard rises automatically. The guard is spring loaded so it returns to its original position when the cut is completed and the handle is raised. NEVER DEFEAT OR REMOVE THE BLADE GUARD OR THE SPRING WHICH ATTACHES TO THE GUARD.

In the interest of your personal safety, always maintain the blade guard in good condition. Any irregular operation of the blade guard should be corrected immediately. Check to assure spring loaded return action of guard. NEVER USE THE TOOL IF THE BLADE GUARD OR SPRING ARE DAMAGED, FAULTY OR REMOVED. DOING SO IS HIGHLY DANGEROUS AND CAN CAUSE SERIOUS PERSONAL INJURY.

If the see-through blade guard becomes dirty, or sawdust adheres to it in such a way that the blade is no longer easily visible, unplug the saw and clean the guard carefully with a damp cloth. Do not use solvents or any petroleum-based cleaners on the plastic guard.

If the blade guard is especially dirty and vision through the guard is impaired, use the supplied socket wrench to loosen the hex bolt holding the center cover. Loosen the hex bolt by turning it counterclockwise and raise the blade guard and center cover. With the blade guard so positioned, cleaning can be more completely and efficiently accomplished. When cleaning is complete, reverse procedure above and secure bolt. Do not remove spring holding blade guard. If guard becomes discolored through age or UV light exposure, contact a Makita service center for a new guard. DO NOT DEFEAT OR REMOVE GUARD.

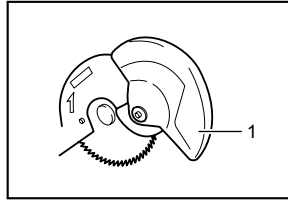

001782

1. Blade guard

### Kerf board

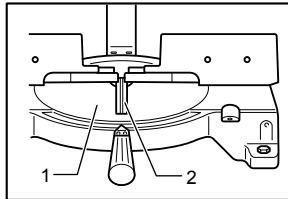

012670

1. Turn base  
2. Kerf board

This tool is provided with the kerf board in the turn base to minimize tearing on the exit side of a cut. If the kerf groove has not yet been cut in the kerf board by the factory, you should cut the groove before actually using the tool to cut a workpiece. Switch on the tool and lower the blade gently to cut a groove in the kerf board.

### Maintaining maximum cutting capacity

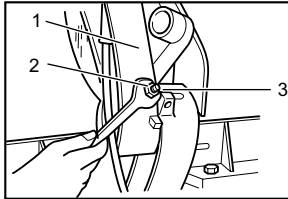

002151

1. Gear housing  
2. Hex nut  
3. Adjusting bolt

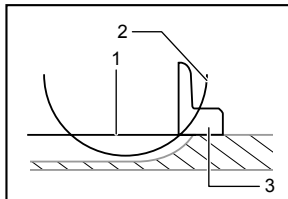

001540

1. Top surface of turn base  
2. Periphery of blade  
3. Guide fence

This tool is factory adjusted to provide the maximum cutting capacity for a 355 mm saw blade.

When installing a new blade, always check the lower limit position of the blade and if necessary, adjust it as follows: First, unplug the tool. Lower the handle completely. Loosen the hex nut at the rear of the gear housing. Use a screwdriver to turn the adjusting bolt until the periphery of

the blade extends slightly below the top surface of the turn base at the point where the front face of the guide fence meets the top surface of the turn base.

With the tool unplugged, rotate the blade by hand while holding the handle all the way down to be sure that the blade does not contact any part of the lower base. Re-adjust slightly, if necessary.

After adjusting, tighten the hex nut with the wrench while carefully holding the adjusting bolt in position with the screwdriver.

At this time, make sure that the handle can be locked in the lowered position by turning the handle latch. If the handle cannot be locked so, turn the adjusting bolt so that the handle can be locked in the lowered position.

**⚠CAUTION:**

- After installing a new blade, always be sure that the blade does not contact any part of the lower base when the handle is lowered completely. Always do this with the tool unplugged.

**Adjusting the miter angle**

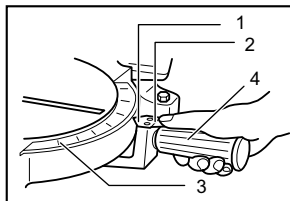

1. Pointer
2. Lock lever
3. Miter scale
4. Grip

002152

Loosen the grip by turning counterclockwise. Turn the turn base while pressing down the lock lever. When you have moved the grip to the position where the pointer points to the desired angle on the miter scale, securely tighten the grip clockwise.

**⚠CAUTION:**

- When turning the turn base, be sure to raise the handle fully.
- After changing the miter angle, always secure the turn base by tightening the grip firmly.

**Fence plate**

The fence plate is designed to prevent smaller cutting scraps from jamming inside the blade case. The fence plate moves right or left automatically as the turn base is rotated.

**Switch action**

**For tools with lock lever**

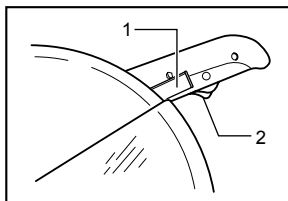

1. Lock lever
2. Switch trigger

011829

Switch on the tool and wait until the blade attains full speed. Pull the lock lever at the side of the handle and then lower the blade gently into the cut.

**⚠CAUTION:**

Before plugging in the tool, always check to see that the switch trigger actuates properly and returns to the "OFF" position when released.

To start the tool, simply pull the switch trigger. Release the switch trigger to stop.

**⚠WARNING:**

- NEVER use tool without a fully operative switch trigger. Any tool with an inoperative switch is HIGHLY DANGEROUS and must be repaired before further usage.

**For tools without lock lever**

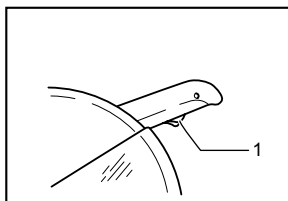

1. Switch trigger

003639

Switch on the tool and wait until the blade attains full speed. Then lower the blade gently into the cut.

**⚠CAUTION:**

- Before plugging in the tool, always check to see that the switch trigger actuates properly and returns to the "OFF" position when released.

To start the tool, simply pull the switch trigger. Release the switch trigger to stop.

**⚠WARNING:**

- NEVER use tool without a fully operative switch trigger. Any tool with an inoperative switch is HIGHLY DANGEROUS and must be repaired before further usage.

# ASSEMBLY

## ⚠ CAUTION:

- Always be sure that the tool is switched off and unplugged before carrying out any work on the tool.

### Installing or removing saw blade

## ⚠ CAUTION:

- Always be sure that the tool is switched off and unplugged before installing or removing the blade.
- Use only the Makita socket wrench provided to install or remove the blade. Failure to do so may result in overtightening or insufficient tightening of the hex bolt. This could cause an injury.

To remove the blade, use the socket wrench to loosen the hex bolt holding the center cover by turning it counterclockwise. Raise the blade guard and center cover.

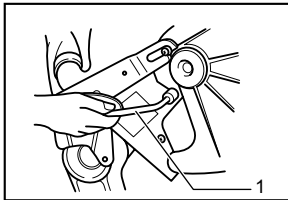

1. Socket wrench

002155

Press the shaft lock to lock the spindle and use the socket wrench to loosen the hex bolt counterclockwise. Then remove the hex bolt, outer flange and blade.

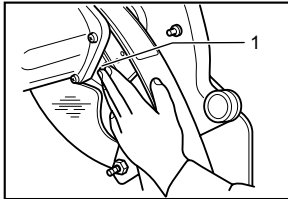

1. Shaft lock

002156

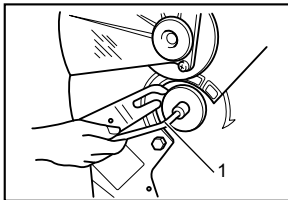

1. Socket wrench

002243

To install the blade, mount it carefully onto the spindle, making sure that the direction of the arrow on the surface of the blade matches the direction of the arrow on the

blade case. Install the outer flange and hex bolt, and then use the socket wrench to tighten the hex bolt securely clockwise while pressing the shaft lock.

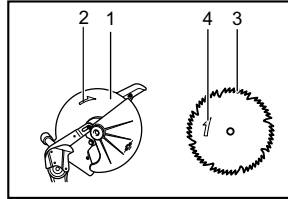

1. Blade case  
2. Arrow  
3. Saw blade  
4. Arrow

002860

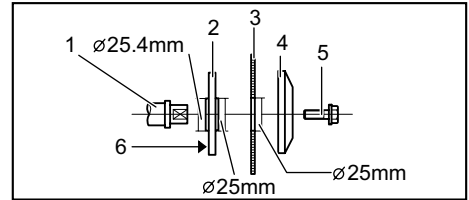

1. Spindle  
2. Inner flange  
3. Blade  
4. Outer flange  
5. Hex bolt  
6. 25.4 mm marking

002154

## ⚠ CAUTION:

- The inner flange has a 25 mm diameter on one side and a 25.4 mm diameter on the other. The side with 25.4 mm diameter is marked by "25.4". Use the correct side for the hole diameter of the blade you intend to use. Mounting the blade on the wrong side can result in dangerous vibration.

Slip the pin on the blade guard into the slot in the guide arm while returning the blade guard to its original fully closed position. Then tighten the hex bolt clockwise to secure the center cover. Lower the handle to make sure that the blade guard moves properly. Make sure shaft lock has released spindle before making cut.

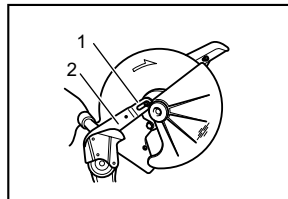

1. Pin  
2. Guide arm

002264



## Dust bag

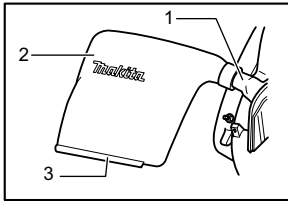

1. Dust nozzle
2. Dust bag
3. Fastener

002157

The use of the dust bag makes cutting operations clean and dust collection easy. To attach the dust bag, fit it onto the dust nozzle.

When the dust bag is about half full, remove the dust bag from the tool and pull the fastener out. Empty the dust bag of its contents, tapping it lightly so as to remove particles adhering to the insides which might hamper further collection.

### NOTE:

If you connect a Makita vacuum cleaner to your saw, more efficient and cleaner operations can be performed.

## Securing workpiece

### ⚠WARNING:

- It is extremely important to always secure the workpiece properly and tightly with the vise. Failure to do so can cause the tool to be damaged and/or the workpiece to be destroyed. **PERSONAL INJURY MAY ALSO RESULT.** Also, after a cutting operation, **DO NOT** raise the blade until the blade has come to a complete stop.

### ⚠CAUTION:

- When cutting long workpieces, use supports that are as high as the top surface level of the turn base. Do not rely solely on the vertical vise and/or horizontal vise to secure the workpiece. Thin material tends to sag. Support workpiece over its entire length to avoid blade pinch and possible **KICKBACK.**

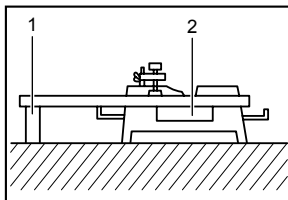

1. Support
2. Turn base

001549

## Horizontal vise (optional accessory)

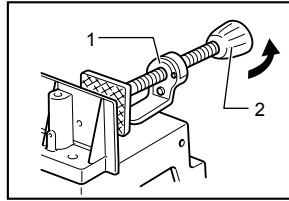

1. Projection
2. Vise knob

012671

The horizontal vise can be installed on either the left or right side of the base. When performing 15° or greater miter cuts, install the horizontal vise on the side opposite the direction in which the turn base is to be turned. By turning the vise knob counterclockwise, the screw is released and the vise shaft can be moved rapidly in and out. By turning the vise knob clockwise, the screw remains secured. To grip the workpiece, turn the vise knob gently clockwise until the projection reaches its topmost position, then fasten securely. If the vise knob is forced in or pulled out while being turned clockwise, the projection may stop at an angle. In this case, turn the vise knob back counterclockwise until the screw is released, before turning again gently clockwise.

### ⚠CAUTION:

- Grip the workpiece only when the projection is at the topmost position. Failure to do so may result in insufficient securing of the workpiece. This could cause the workpiece to be thrown, cause damage to the blade or cause the loss of control, which can result in **PERSONAL INJURY.**

## Vertical vise (optional accessory)

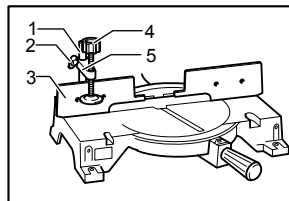

1. Vise rod
2. Screw
3. Guide fence
4. Vise knob
5. Vise arm

012676

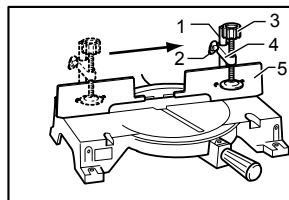

1. Vise rod
2. Screw
3. Vise knob
4. Vise arm
5. Guide fence

012677

The vertical vise can be installed in the position on either the left or right side of the guide fence. Insert the vise rod into the hole in the guide fence and tighten the screw to secure the vise rod.

Position the vise arm according to the thickness and shape of the workpiece and secure the vise arm by tightening the screw. If the screw to secure the vise arm contacts the guide fence, install the screw on the opposite side of vise arm. Make sure that no part of the tool contacts the vise when lowering the handle all the way. If some part contacts the vise, re-position the vise. Press the workpiece flat against the guide fence and the turn base. Position the workpiece at the desired cutting position and secure it firmly by tightening the vise knob.

**⚠ CAUTION:**

- The workpiece must be secured firmly against the turn base and guide fence with the vise during all operations.

## OPERATION

**⚠ CAUTION:**

- Before use, be sure to release the handle from the lowered position by turning the handle latch to the released position.
- Make sure the blade is not contacting the workpiece, etc. before the switch is turned on.
- Do not apply excessive pressure on the handle when cutting. Too much force may result in overload of the motor and/or decreased cutting efficiency. Push down handle with only as much force as is necessary for smooth cutting and without significant decrease in blade speed.
- Gently press down the handle to perform the cut. If the handle is pressed down with force or if lateral force is applied, the blade will vibrate and leave a mark (saw mark) in the workpiece and the precision of the cut will be impaired.

### 1. Press cutting

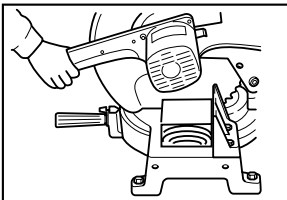

002159

Secure the workpiece with the vise. Switch on the tool without the blade making any contact and wait until the blade attains full speed before lowering. Then gently lower the handle to the fully lowered

position to cut the workpiece. When the cut is completed, switch off the tool and WAIT UNTIL THE BLADE HAS COME TO A COMPLETE STOP before returning the blade to its fully elevated position.

### 2. Miter cutting

Refer to the previously covered "Adjusting the miter angle".

### 3. Cutting aluminum extrusion

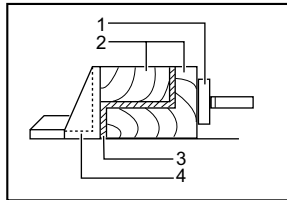

002861

1. Horizontal vise
2. Spacer block
3. Aluminum extrusion
4. Guide fence

When securing aluminum extrusions, use spacer blocks or pieces of scrap as shown in the figure to prevent deformation of the aluminum. Use a cutting lubricant when cutting the aluminum extrusion to prevent build-up of the aluminum material on the blade.

**⚠ CAUTION:**

- Never attempt to cut thick or round aluminum extrusions. Thick aluminum extrusions may come loose during operation and round aluminum extrusions cannot be secured firmly with this tool.

### 4. Wood facing

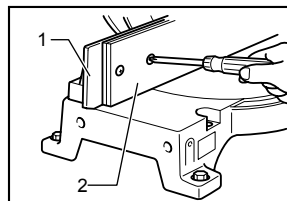

012672

1. Guide fence
2. Wood facing

Use of wood facing helps to assure splinter-free cuts in workpieces. Attach a wood facing to the guide fence using the holes in the guide fence. See the figure concerning the dimensions for a suggested wood facing.

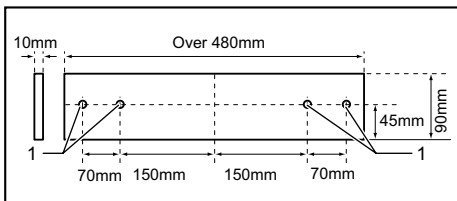

1. Hole

012867

**CAUTION:**

- Use straight wood of even thickness as the wood facing.
- Use screws to attach the wood facing to the guide fence. The screws should be installed so that the screw heads are below the surface of the wood facing.
- When the wood facing is attached, do not turn the turn base with the handle lowered. The blade and/or the wood facing will be damaged.

**NOTE:**

- When the wood facing is attached, the maximum cutting capacities in width will be reduced by thickness of the wood facing.

**5. Cutting repetitive lengths**

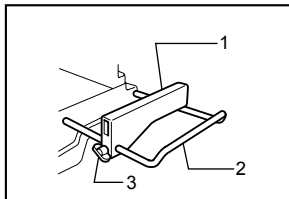

001846

1. Set plate
2. Holder
3. Screw

When cutting several pieces of stock to the same length, ranging from 300 mm to 400 mm, use of the set plate (optional accessory) will facilitate more efficient operation. Install the set plate on the holder (optional accessory) as shown in the figure. Align the cutting line on your workpiece with either the left or right side of the groove in the kerf board, and while holding the workpiece from moving, move the set plate flush against the end of the workpiece. Then secure the set plate with the screw. When the set plate is not used, loosen the screw and turn the set plate out of the way.

**NOTE:**

- Use of the holder-rod assembly (optional accessory) allows cutting repetitive lengths up to 2,200 mm approximately.

**Carrying tool**

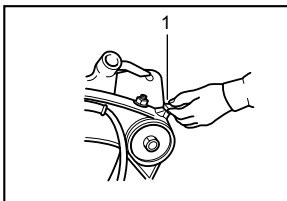

002147

1. Handle latch

Make sure that the tool is unplugged. Secure the turn base at right miter angle fully by means of the grip. Lower the handle fully and lock it in the lowered position by turning the handle latch to the locked position. Carry the tool by holding both sides of the tool base as shown in the figure. If you remove the holders, dust bag, etc., you can carry the tool more easily.

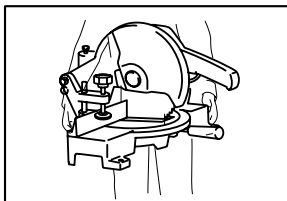

002263

**CAUTION:**

- Always secure all moving portions before carrying the tool.
- Handle latch is for carrying and storage purposes only and not for any cutting operations.

**MAINTENANCE**

**CAUTION:**

- Always be sure that the tool is switched off and unplugged before attempting to perform inspection or maintenance.
- Never use gasoline, benzine, thinner, alcohol or the like. Discoloration, deformation or cracks may result.

**WARNING:**

- Always be sure that the blade is sharp and clean for the best and safest performance.

**Adjusting the cutting angle**

This tool is carefully adjusted and aligned at the factory, but rough handling may have affected the alignment. If your tool is not aligned properly, perform the following:

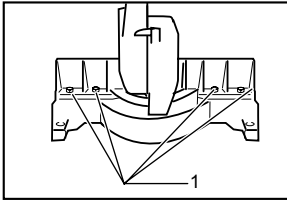

1. Hex bolt

002162

Loosen the grip which secures the turn base. Turn the turn base so that the pointer points to 0° on the miter scale. Then turn the turn base slightly clockwise and counterclockwise to seat the turn base in the 0° miter notch. (Leave as it is if the pointer does not point to 0°.) Loosen the hex bolts securing the guide fence using the socket wrench. Lower the handle fully and lock it in the lowered position by turning the handle latch to the locked position. Square the side of the blade with the face of the guide fence using a triangular rule, try-square, etc. Then securely tighten the hex bolts on the guide fence in the order from the right side.

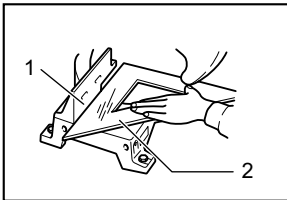

1. Guide fence
2. Triangular rule

002163

Make sure that the pointer on the indication plate points to 0° on the miter scale. If the pointer does not point to 0°, loosen the screws which secure the indication plate and adjust it so that the pointer will point to 0°.

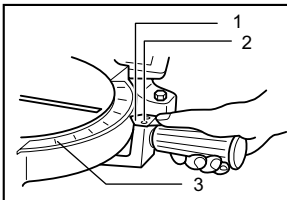

1. Pointer
2. Screws
3. Miter scale

002265

## Adjusting for smooth handle action

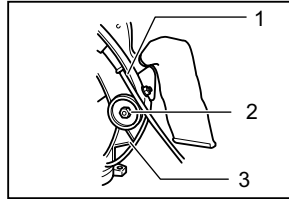

1. Gear housing
2. Hex lock nut
3. Arm

002161

The hex lock nut which holds the gear housing and the arm has been factory adjusted to assure smooth handle action up and down and to guarantee precise cutting. Do not tamper with it. Should looseness develop at the gear housing and arm connection, perform the following adjustment. Work the handle up and down while tightening the hex lock nut; the best position to tighten the hex lock nut is just before the motor body weight is obvious.

After adjusting the hex lock nut, be sure that the handle returns automatically to the initial, raised position from any position. If the hex lock nut is too loose, the cutting accuracy will be affected; if it is too tight, it will be hard to work the handle up and down. Note that this is a self locking nut. It is a special type that does not loosen in normal use. It should not be overtightened or replaced with other types of nuts.

## Replacing carbon brushes

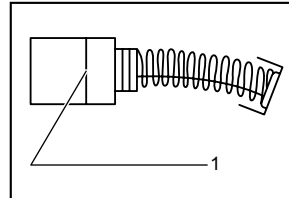

1. Limit mark

001145

Remove and check the carbon brushes regularly. Replace when they wear down to the limit mark. Keep the carbon brushes clean and free to slip in the holders. Both carbon brushes should be replaced at the same time. Use only identical carbon brushes.

Use a screwdriver to remove the brush holder caps. Take out the worn carbon brushes, insert the new ones and secure the brush holder caps.

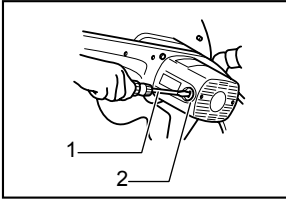

1. Screwdriver
2. Brush holder cap

002164

### After use

- After use, wipe off chips and dust adhering to the tool with a cloth or the like. Keep the blade guard clean according to the directions in the previously covered "Blade guard". Lubricate the sliding portions with tool oil to prevent rust.

To maintain product SAFETY and RELIABILITY, repairs, any other maintenance or adjustment should be performed by Makita Authorized Service Centers, always using Makita replacement parts.

## OPTIONAL ACCESSORIES

### ⚠CAUTION:

- These accessories or attachments are recommended for use with your Makita tool specified in this manual. The use of any other accessories or attachments might present a risk of injury to persons. Only use accessory or attachment for its stated purpose.

If you need any assistance for more details regarding these accessories, ask your local Makita Service Center.

- Carbide-tipped saw blades
- Socket wrench 13
- Holder set
- Set plate
- Dust bag
- Triangular rule
- Vise assembly (Horizontal vise)
- Vise assembly (Vertical vise)

### NOTE:

- Some items in the list may be included in the tool package as standard accessories. They may differ from country to country.





**Makita Corporation**  
Anjo, Aichi, Japan

883619B224

[www.makita.com](http://www.makita.com)